

## CHAPTER 2

***Knots, Splices, Attachments, and  
Ladders*****Section I. Knots, Hitches, and Lashings**

A study of the terminology pictured in *Figure 2-1* and the definitions in *Table 2-1*, page 2-2, will aid in understanding the methods of knotting presented in this section.

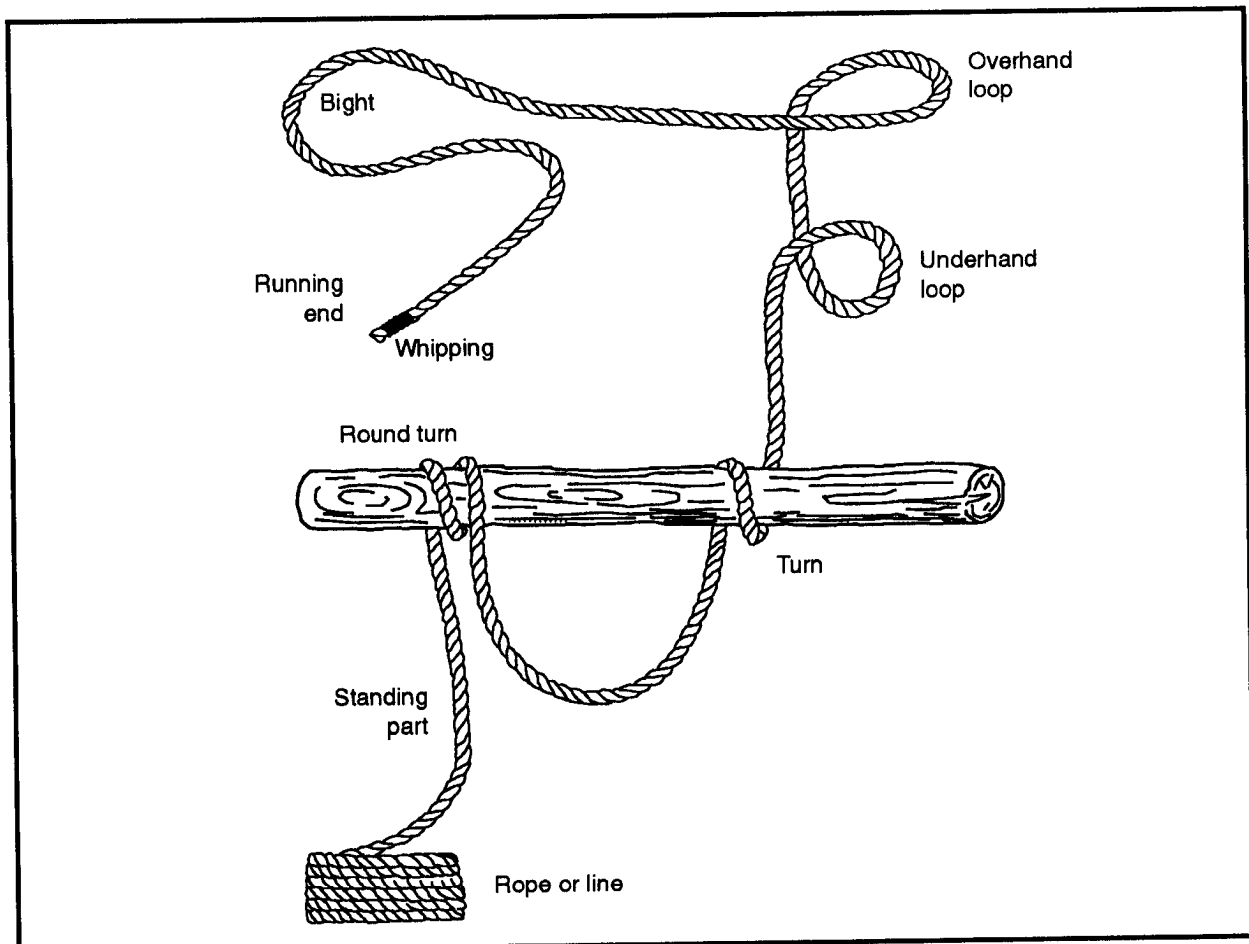

**Figure 2-1. Elements of knots, bends, and hitches**

Table 2-1. Knotting terminology and definitions

Term	Definition
Rope (often called a line)	A large, stout cord made of strands of fiber or wire that are twisted or braided together
Line (sometimes called a rope)	A thread, string, cord, or rope, especially a comparatively slender and strong cord (This manual will use the word rope rather than line in describing knots, hitches, rigging, and the like.)
Running end	The free or working end of a rope
Standing part	The rest of the rope, excluding the running end
Bight	A bend or U-shaped curve in a rope
Loop	Formed by crossing the running end over or under the standing part, forming a ring or circle in the rope
Turn	The placing of a loop around a specific object (such as a post, rail, or ring) with the running end continuing in a direction opposite to the standing part
Round turn	A modified turn, but with the running end leaving the circle in the same general direction as the standing part
Overhand turn or loop	Made when the running end passes over the standing part
Underhand turn or loop	Made when the running end passes under the standing part
Bend (in this manual, called a knot)	Used to fasten two ropes together or to fasten a rope to a ring or loop

The raw, cut end of a rope has a tendency to untwist and should always be knotted or fastened in some manner to prevent this untwisting. Whipping is one method of fastening the end of the rope to prevent untwisting (see *Figure 2-2*). A rope is whipped by wrapping the end tightly with a small cord. This method is particularly satisfactory because there is very little increase in

the size of the rope. The whipped end of a rope will still thread through blocks or other openings. Before cutting a rope, place two whippings on the rope 1 or 2 inches apart and make the cut between the whippings (see *Figure 2-2*). This will prevent the cut ends from untwisting immediately after they are cut.

### KNOTS

A knot is an interlacement of the parts of one or more flexible bodies, such as cordage rope, forming a lump. It is also any tie or fastening formed with a rope, including bends, hitches, and splices. A knot is often

used as a stopper to prevent a rope from passing through an opening.

A good knot must be easy to tie, must hold without slipping, and must be easy to untie. The choice of the best knot, bend, or

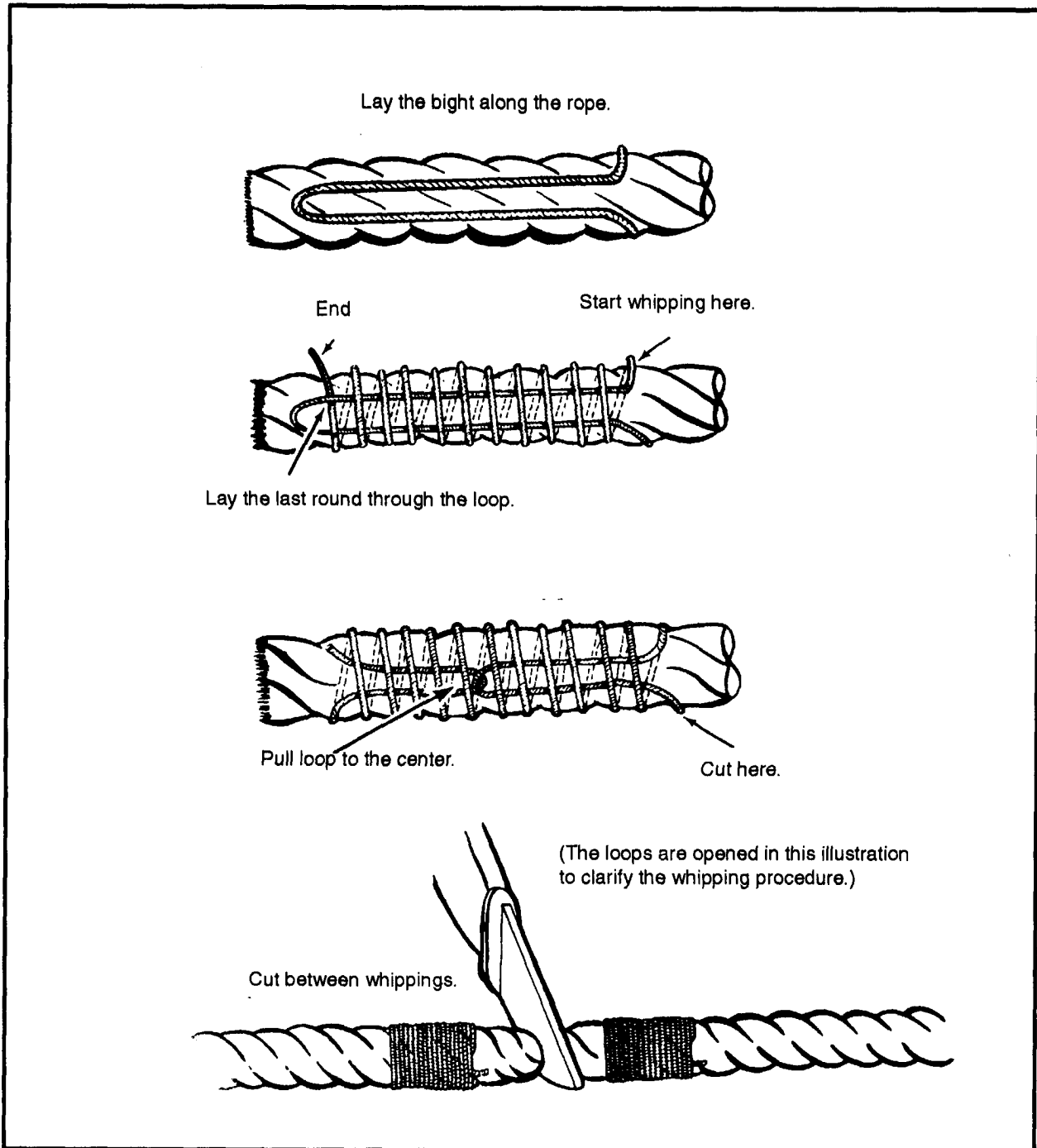

Figure 2-2. Whipping the end of a rope

hitch to use depends largely on the job it has to do. In general, knots can be classified into three groups. They are—

- Knots at the end of a rope.
- Knots for joining two ropes.
- Knots for making loops.

**KNOTS AT THE END OF ROPE**

Knots at the end of a rope fall into the following categories:

- Overhand knot.
- Figure-eight knot.
- Wall knot.

**Overhand Knot**

The overhand knot is the most commonly used and the simplest of all knots (see *Figure 2-3*). Use an overhand knot to prevent

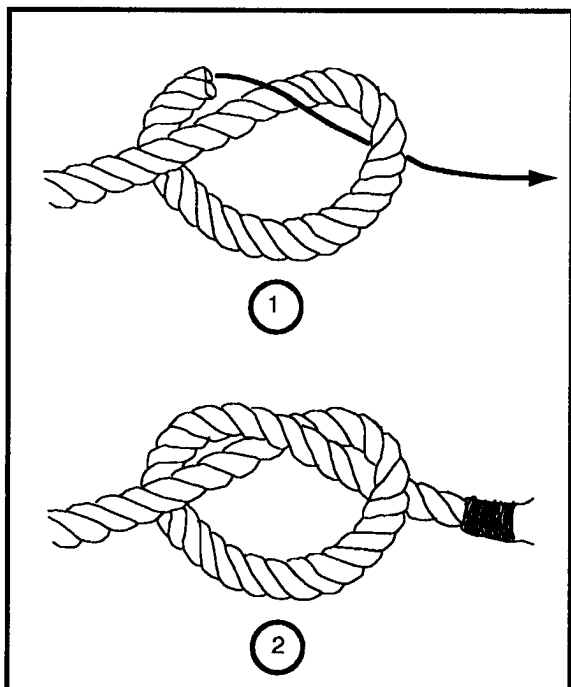

**Figure 2-3. Overhand knot**

the end of a rope from untwisting, to form a knob at the end of a rope, or to serve as a part of another knot. When tied at the end or standing part of a rope, this knot prevents it from sliding through a block, hole, or another knot. Use it also to increase a person's grip on a rope. This knot reduces the strength of a straight rope by 55 percent.

**Figure-Eight Knot**

Use the figure-eight knot to form a larger knot at the end of a rope than would be formed by an overhand knot (see *Figure 2-4*). The knot prevents the end of the rope from slipping through a fastening or loop in another rope or from unreeving when reeved through blocks. It is easy to untie.

**Wall Knot**

Use the wall knot with crown to prevent the end of a rope from untwisting when an

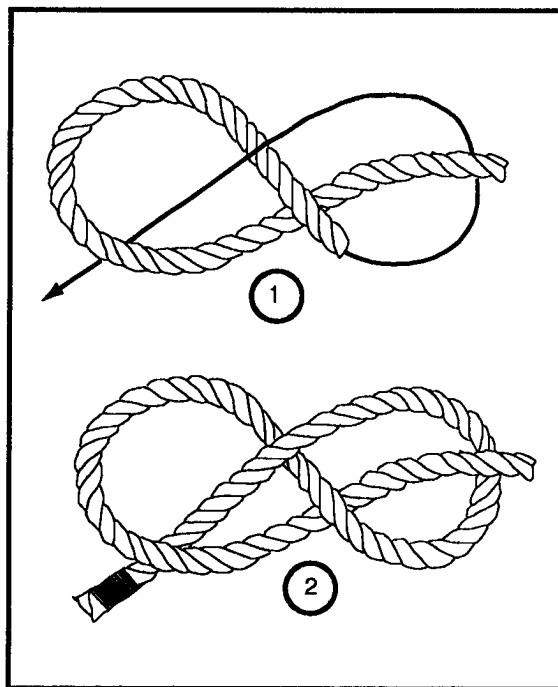

**Figure 2-4. Figure-eight knot**

enlarged end is not objectionable (see *Figure 2-5*). The wall knot also makes a desirable knot to prevent the end of the rope from slipping through small openings, as when using rope handles on boxes. Use either the crown or the wall knot separately to form semipermanent "stopper knots" tied with the end strands of a rope. The wall knot will prevent the rope from untwisting, but to make a neat round knob, crown it (see *Figure 2-6*, page 2-6). Notice that in the wall knot, the ends come up through the bights, causing the strands to lead forward. In a crown knot, the ends go down through the bights and point backward.

### KNOTS FOR JOINING TWO ROPES

Knots for joining two ropes fall into the following categories:

- Square knot.
- Single sheet bend.
- Double sheet bend.
- Carrick bend.

#### Square Knot

Use the square knot to tie two ropes of equal size together so they will not slip (see

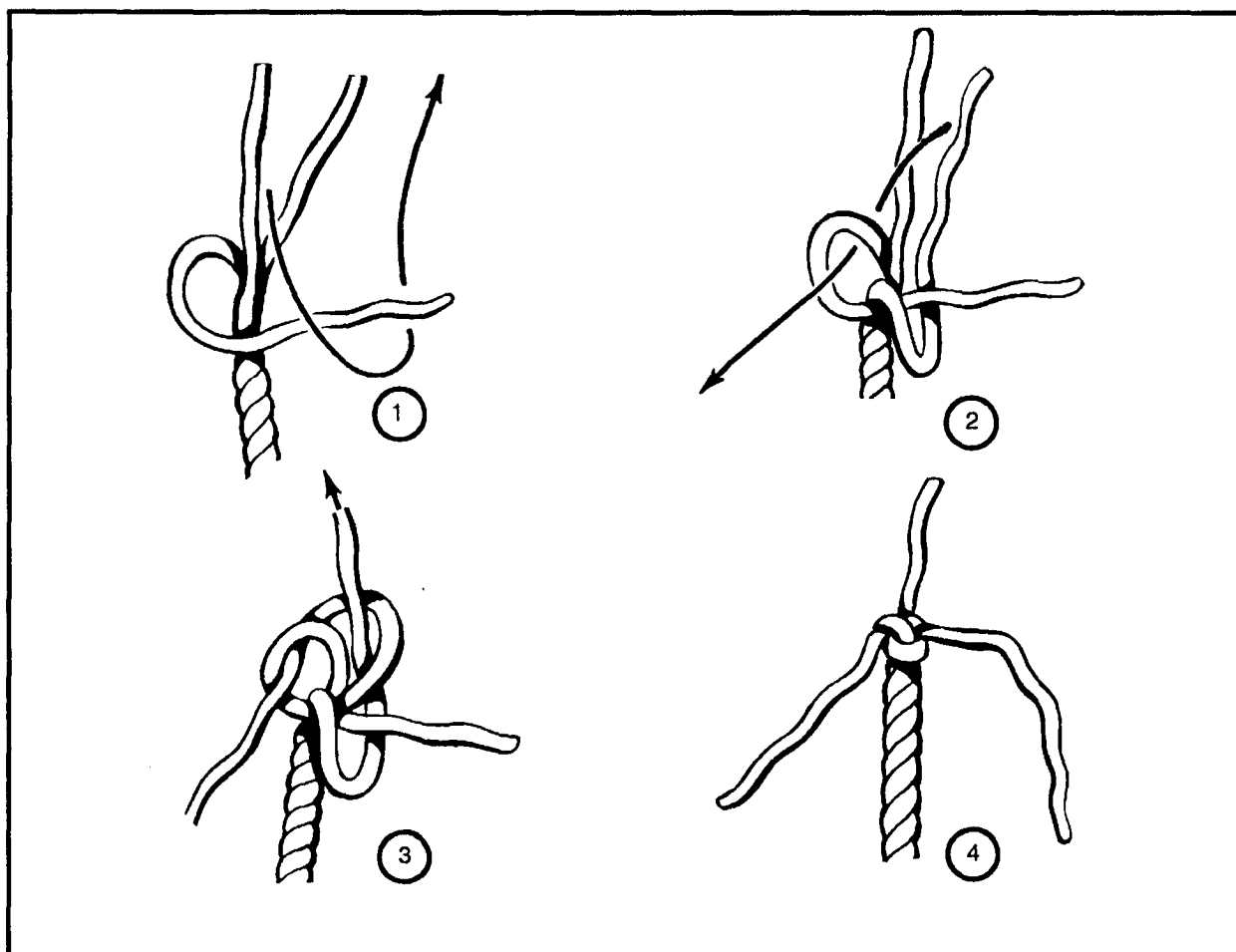

Figure 2-5. Wall knot

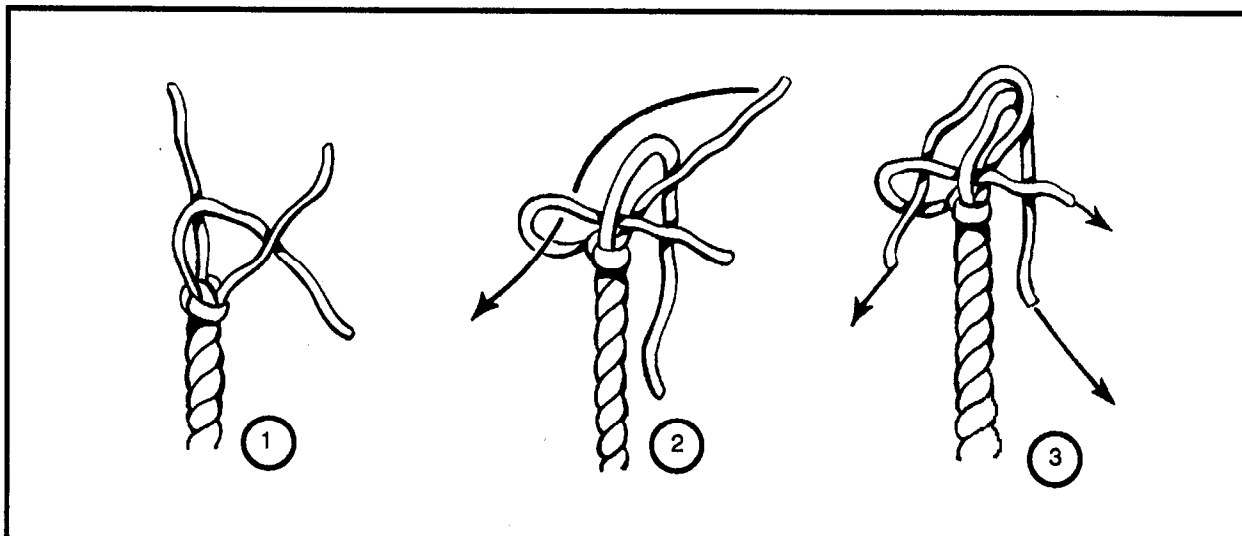

Figure 2-6. Crown on a wall knot

Figure 2-7). Note that in the square knot, the end and standing part of one rope come out on the same side of the bight formed by the other rope. The square knot will not hold if the ropes are wet or if they are of different sizes. It tightens under strain but can be untied by grasping the ends of the two bights and pulling the knot apart.

**NOTE.** It makes no difference whether the first crossing is tied left-over-right or right-over-left as long as the second crossing is tied opposite to the first crossing.

### Single Sheet Bend

A single sheet bend, sometimes called a weaver's knot, has two major uses (see Figure 2-8). They are—

- Tying together two ropes of unequal size.
- Tying a rope to an eye.

This knot will draw tight but will loosen or slip when the lines are slackened. The single sheet bend is stronger and unties easier than the square knot.

### Double Sheet Bend

The double sheet bend has greater holding power than the single sheet bend for joining ropes of equal or unequal diameter, joining wet ropes, or tying a rope to an eye (see Figure 2-9, page 2-8.). It will not slip or draw tight under heavy loads. This knot is more secure than the single sheet bend when used in a spliced eye.

### Carrick Bend

Use the carrick bend for heavy loads and for joining large hawsers or heavy rope (see Figure 2-10, page 2-8). It will not draw tight under a heavy load and can be untied easily if the ends are seized to their own standing part.

### KNOTS FOR MAKING LOOPS

Knots for making loops fall into the following categories:

- Bowline.
- Double bowline.
- Running bowline.

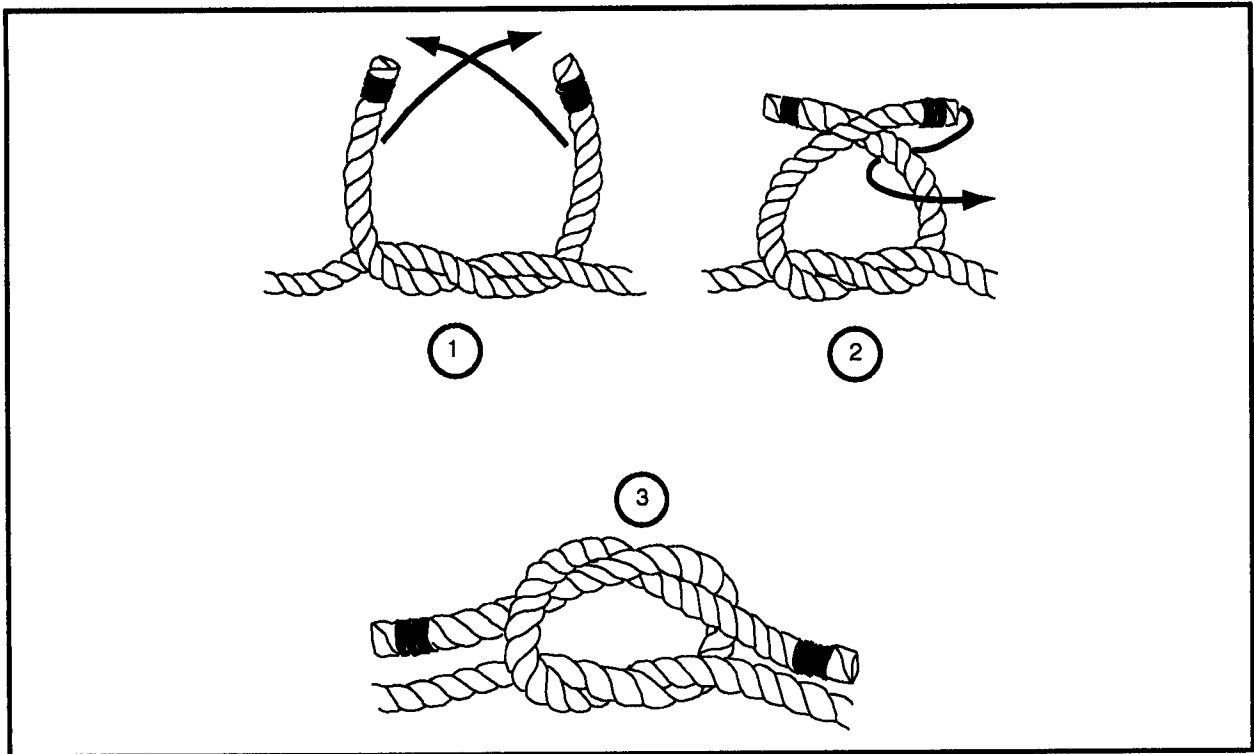

Figure 2-7. Square knot

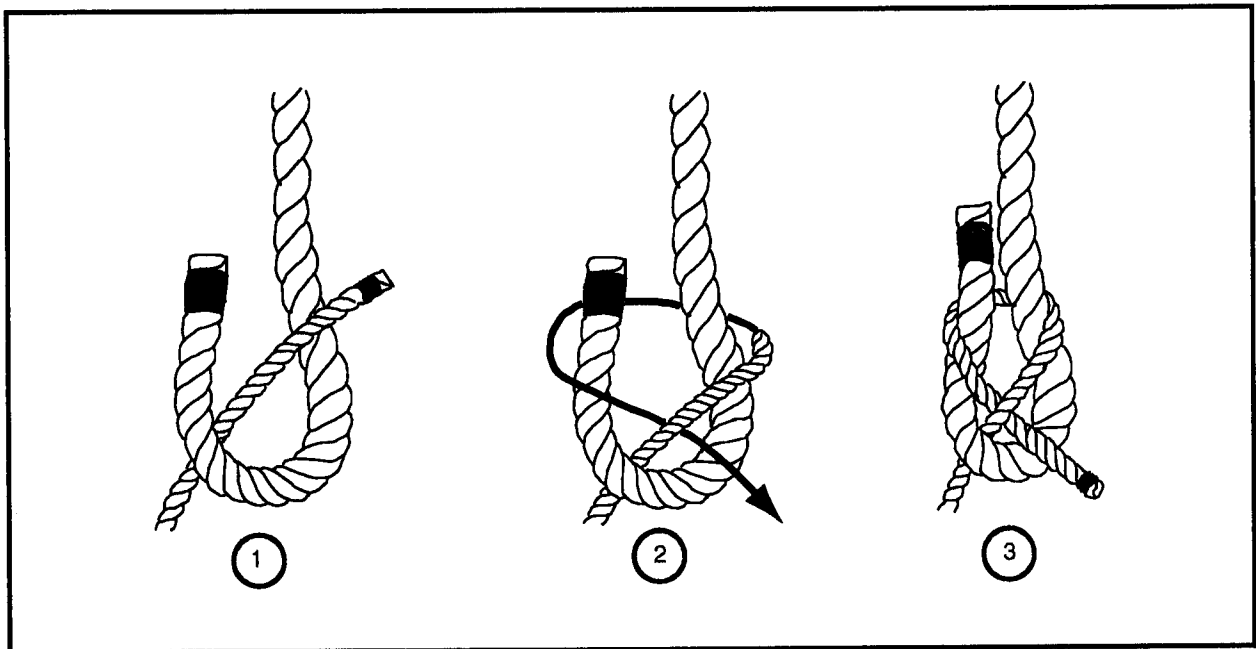

Figure 2-8. Single sheet bend

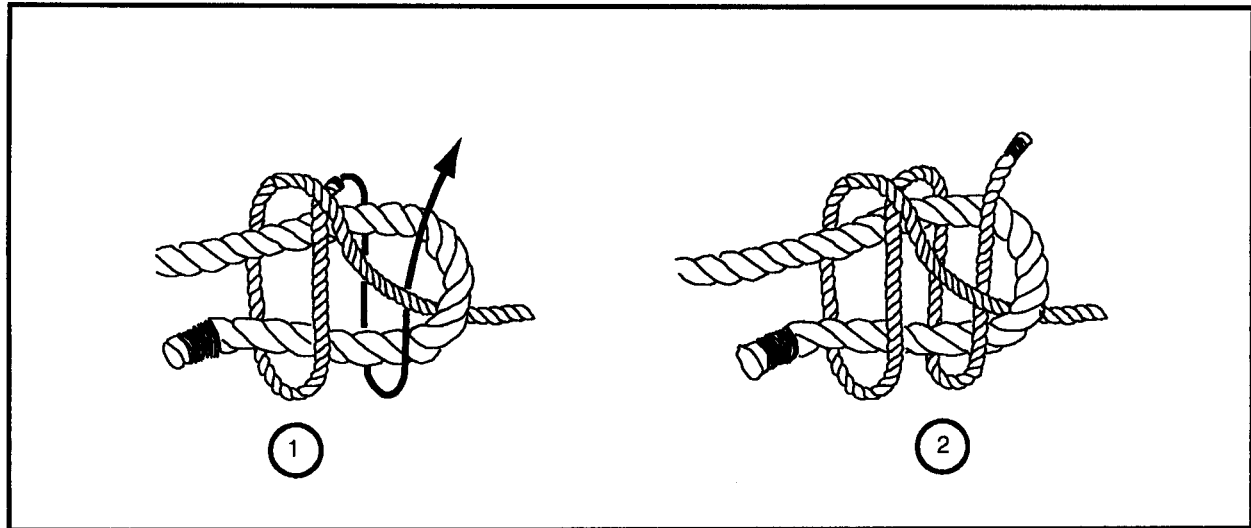

Figure 2-9. Double sheet bend

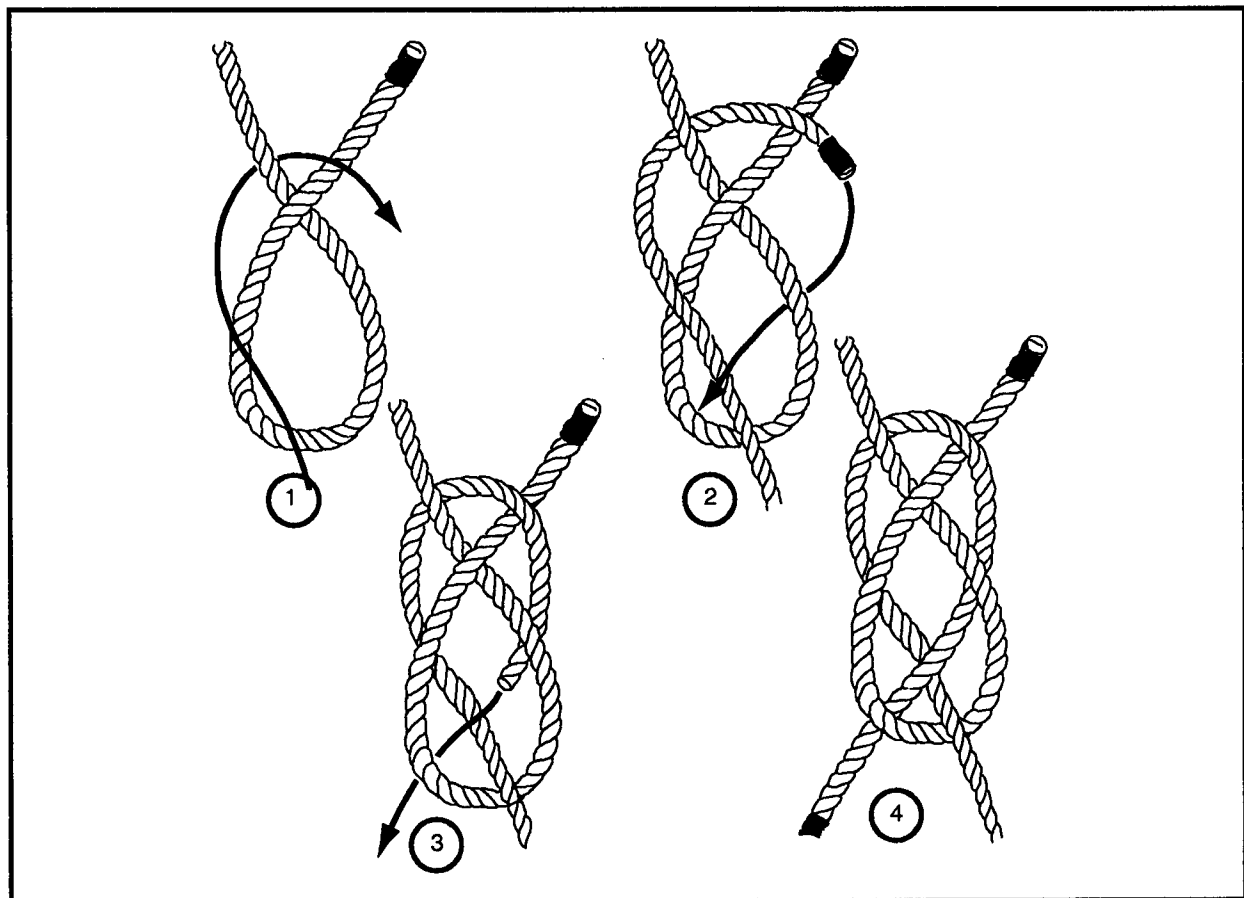

Figure 2-10. Carrick bend



- Bowline on a bight.
- Spanish bowline.
- French bowline.
- Speir knot.
- Cat's-paw.
- Figure eight with an extra turn.

### Bowline

The bowline is one of the most common knots and has a variety of uses, one of which is the lowering of men and material (see *Figure 2-11*). It is the best knot for forming a single loop that will not tighten or slip under strain and can be untied easily if each running end is seized to its own standing part. The bowline forms a loop that may be of any length.

### Double Bowline

The double bowline forms three nonslipping loops (see *Figure 2-12*, page 2-10). Use this knot to sling a man. As he sits in the slings, one loop supports his back and the remain-

ing two loops support his legs. A notched board that passes through the two loops makes a comfortable seat known as a boatswain's chair. This chair is discussed in the scaffolding section of this manual (see *Chapter 6*).

### Running Bowline

The running bowline forms a strong running loop (see *Figure 2-13*, page 2-10). It is a convenient form of running an eye. The running bowline provides a sling of the choker type at the end of a single line. Use it when tying a handline around an object at a point that you cannot safely reach, such as the end of a limb.

### Bowline on a Bight

This knot forms two nonslipping loops (see *Figure 2-14*, page 2-11). You can use the bowline on a bight for the same purpose as a boatswain's chair. It does not leave both hands free, but its twin nonslipping loops form a comfortable seat. Use it when—

- You need more strength than a single bowline will give.

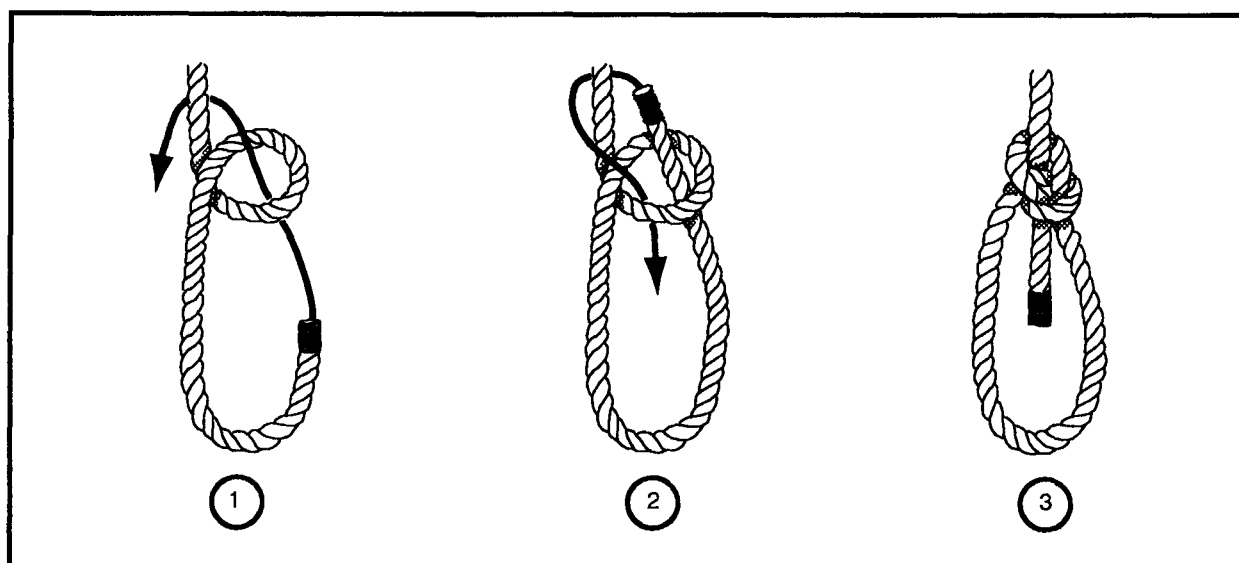

Figure 2-11. Bowline

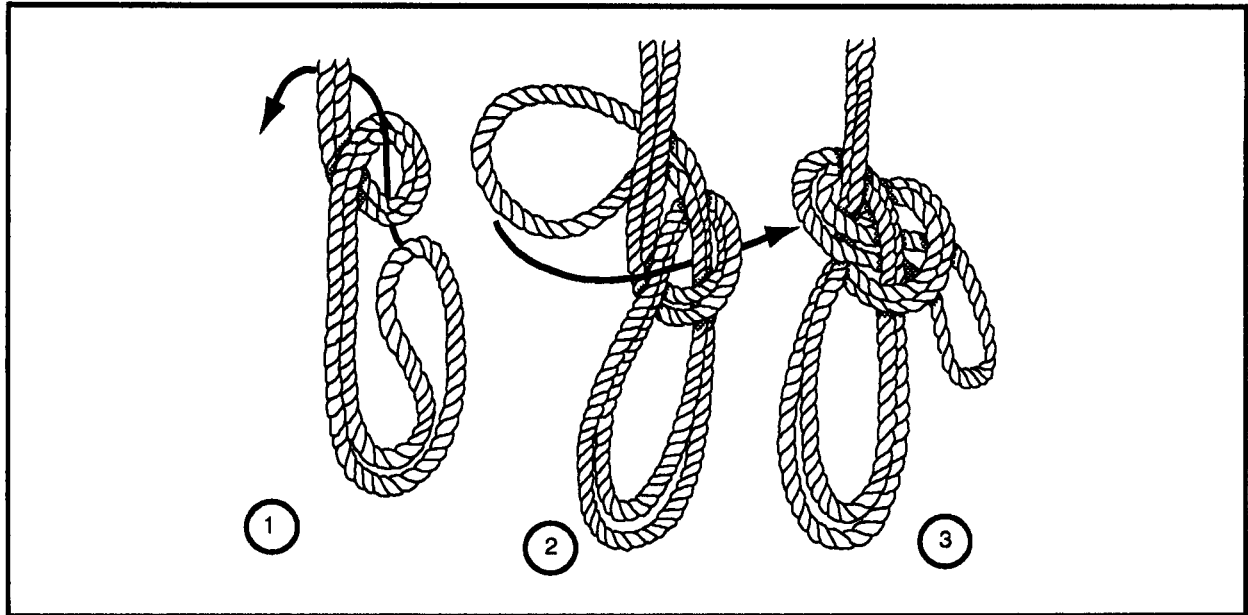

Figure 2-12. Double bowline

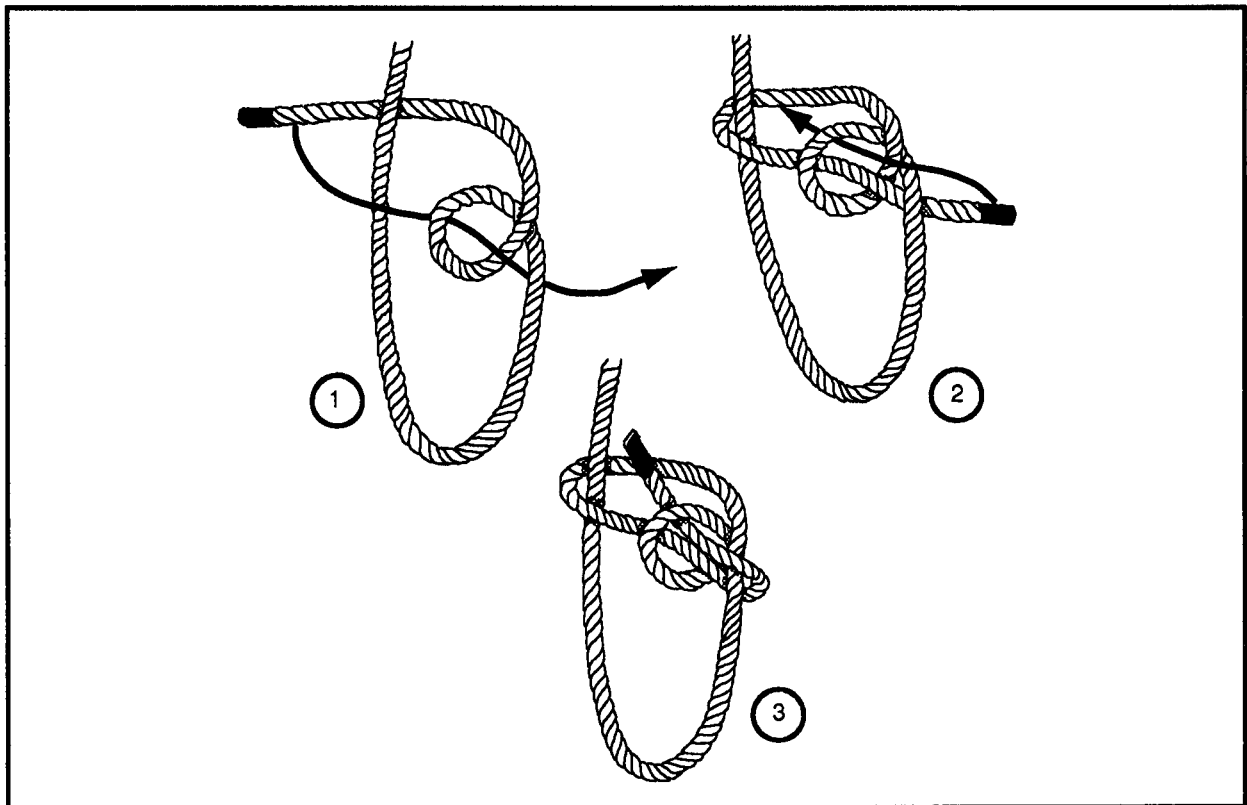
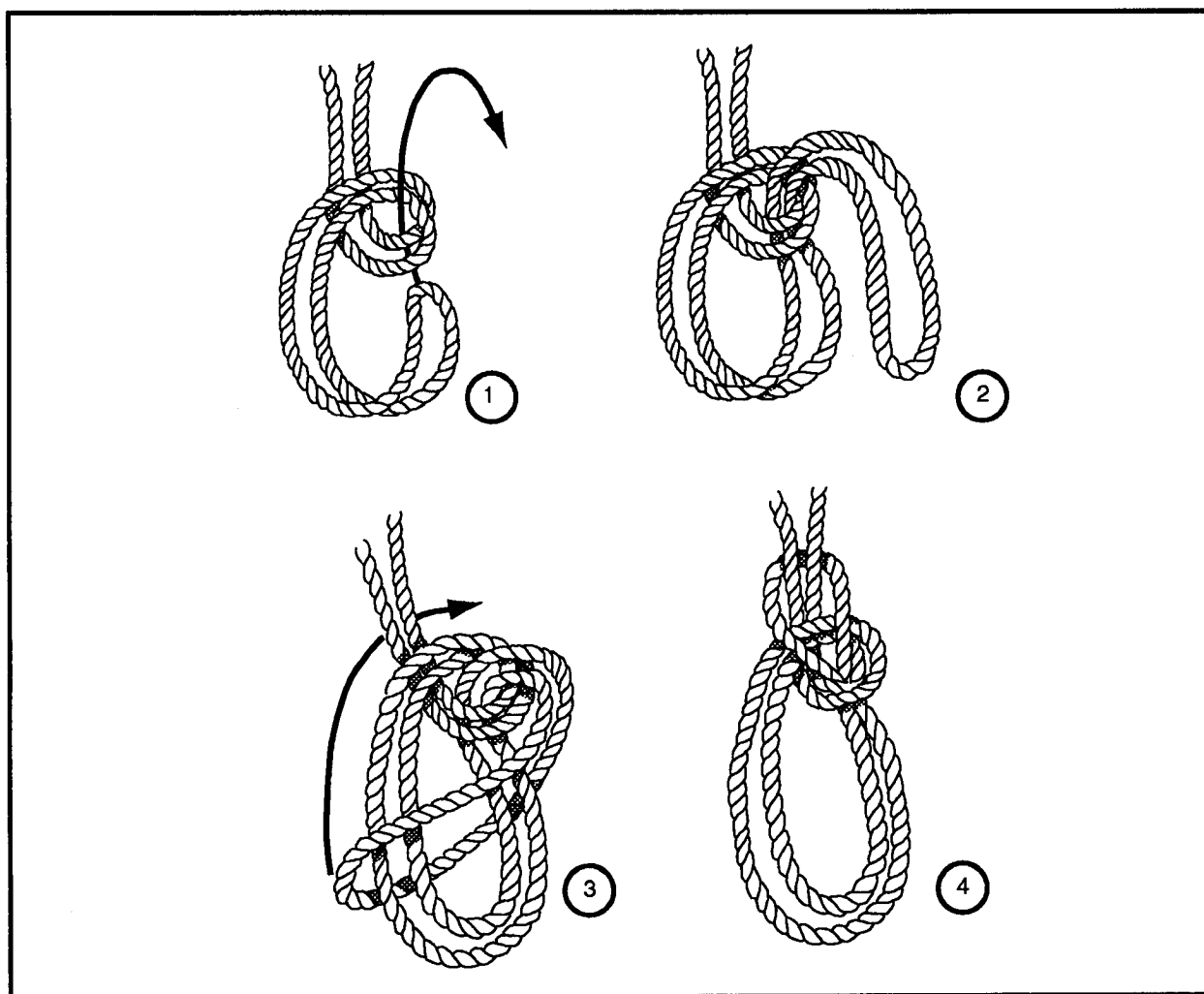

Figure 2-13. Running bowline



**Figure 2-14. Bowline on a bight**

- You need to form a loop at some point in a rope other than at the end.
- You do not have access to the end of a rope.

You can easily untie the bowline on a bight and tie it at the end of a rope by doubling the rope for a short section.

### Spanish Bowline

You can tie a Spanish bowline at any point in a rope, either at a place where the line is double or at an end that has been doubled back (see *Figure 2-15, page 2-12*). Use the

Spanish bowline in rescue work or to give a twofold grip for lifting a pipe or other round objects in a sling.

### French Bowline

You can use the French bowline as a sling to lift injured men (see *Figure 2-16, page 2-12*). When used for this purpose, one loop is a seat and the other loop is put around the body under the arms. The injured man's weight keeps the two loops tight so that he cannot fall out. It is particularly useful as a sling for an unconscious man. Also, use the French bowline when working alone and you

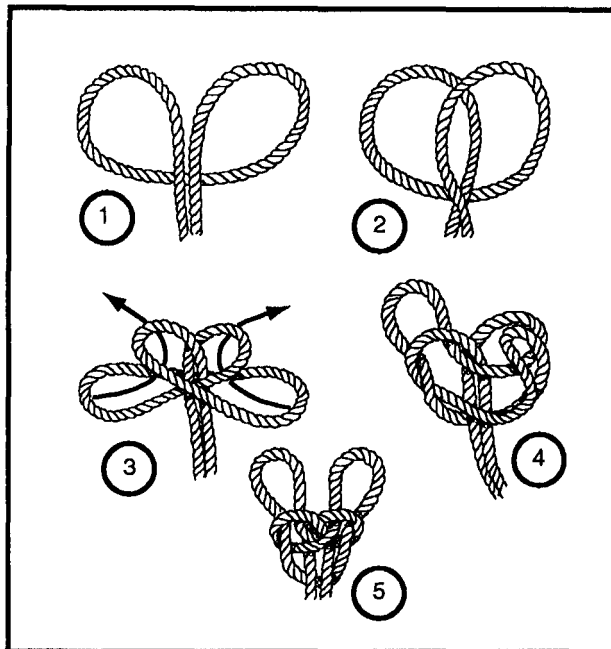

**Figure 2-15. Spanish bowline**

need your hands free. The two loops of this knot can be adjusted to the size required.

### Spear Knot

Use a spear knot when you need a fixed loop, a nonslip knot, and a quick release (see *Figure 2-17*). You can tie this knot quickly and release it by pulling on the running end.

### Cat's-paw

Use a cat's-paw to fasten an endless sling to a hook, or make it at the end of a rope to fasten the rope to a hook (see *Figure 2-18*). You can tie or untie it easily. This knot, which is really a form of a hitch, is a more satisfactory way of attaching a rope to a hook than the blackwall hitch. It will not slip off and need not be kept taut to make it hold.

### Figure Eight With an Extra Turn

Use a figure eight with an extra turn to tighten a rope (see *Figure 2-19, page 2-14*). This knot is especially suitable for tightening

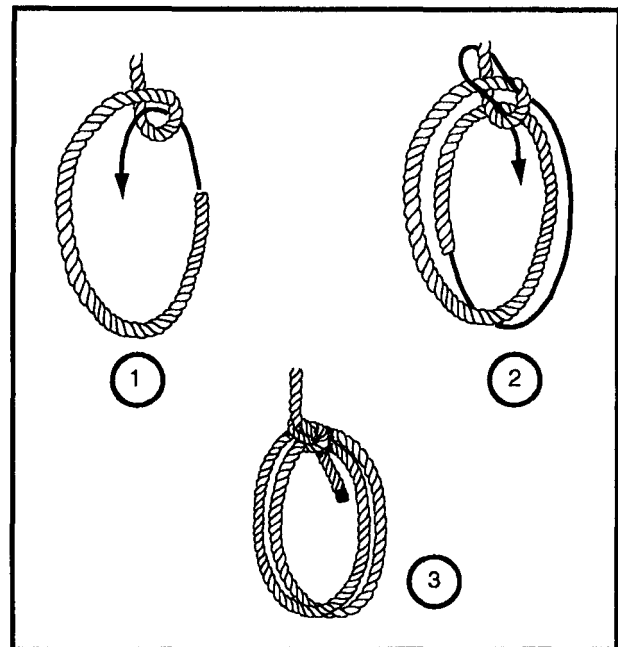

**Figure 2-16. French bowline**

a one-rope bridge across a small stream. You can tie and untie it easily.

### KNOTS FOR TIGHTENING A ROPE

The types of knots used for tightening a rope are the butterfly knot and the baker bowline.

### Butterfly Knot

Use the butterfly knot to pull taut a high line, handline, tread rope for foot bridges, or similar installations (see *Figure 2-20, page 2-14*). Using this knot provides the capability to tighten a fixed rope when mechanical means are not available. (You can also use the harness hitch for this purpose [see *Figure 2-32, page 2-22*]). The butterfly knot will not jam if a stick is placed between the two upper loops.

### Baker Bowline

You can use the baker bowline for the same purpose as the butterfly knot and for lashing cargo (see *Figure 2-21, pages 2-15 and 2-16*).

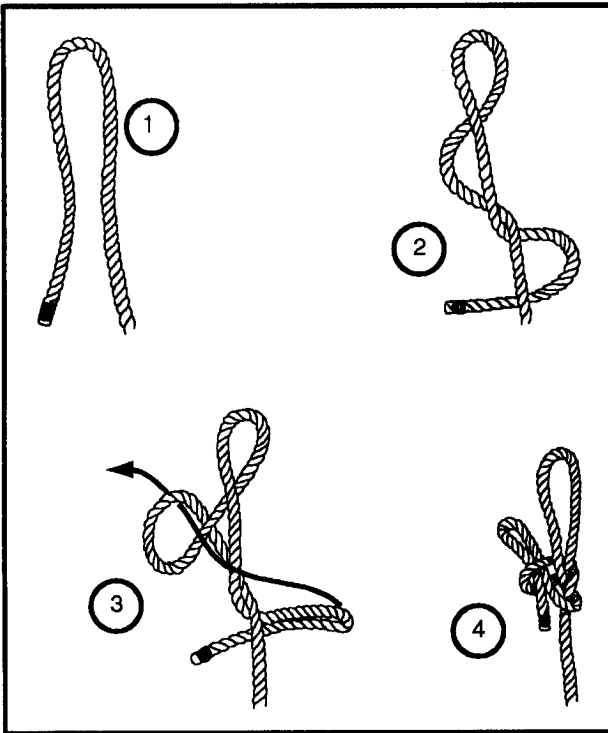

Figure 2-17. Speir knot

When used to lash cargo, secure one end with two half hitches, pass the rope over the cargo and tie a baker bowline, then secure the lashing with a slippery half hitch. To release the rope, simply pull on the running end. Advantages of the baker bowline are that it can be—

- Tied easily.
- Adjusted without losing control.
- Released quickly.

### KNOTS FOR WIRE ROPE

Under special circumstances, when wire-rope fittings are not available and it is necessary to fasten wire rope by some other manner, you can use certain knots. In all knots made with wire rope, fasten the running end of the rope to the standing part after tying the knot. When wire-rope clips are available, use them to fasten the running end. If clips are not available, use

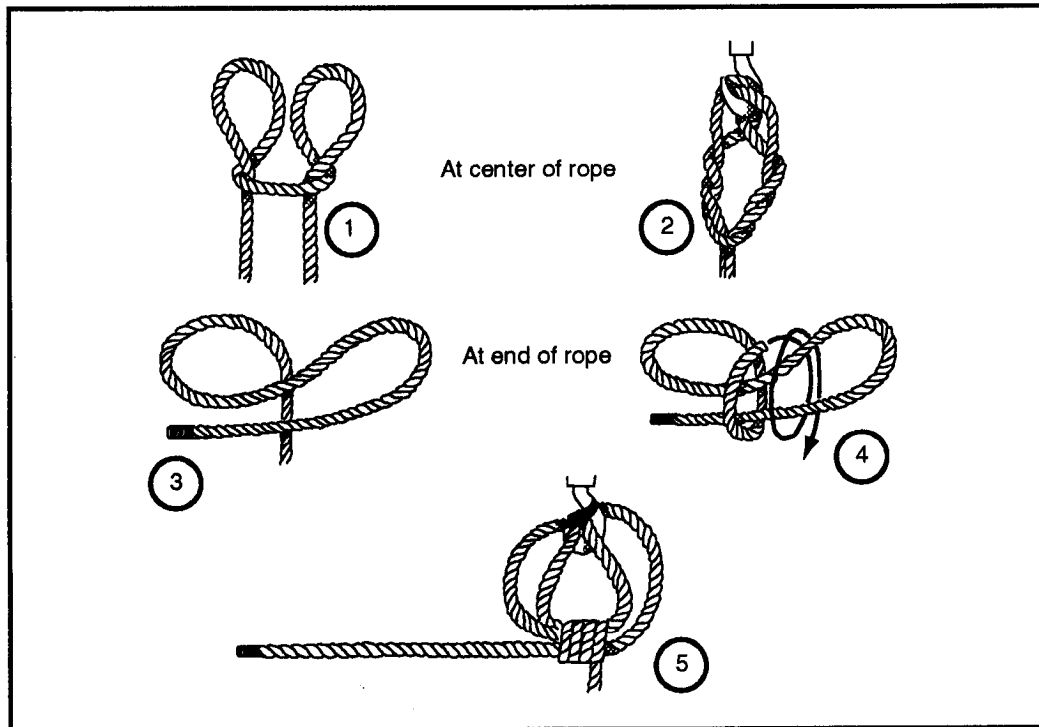

Figure 2-18. Cats-paw

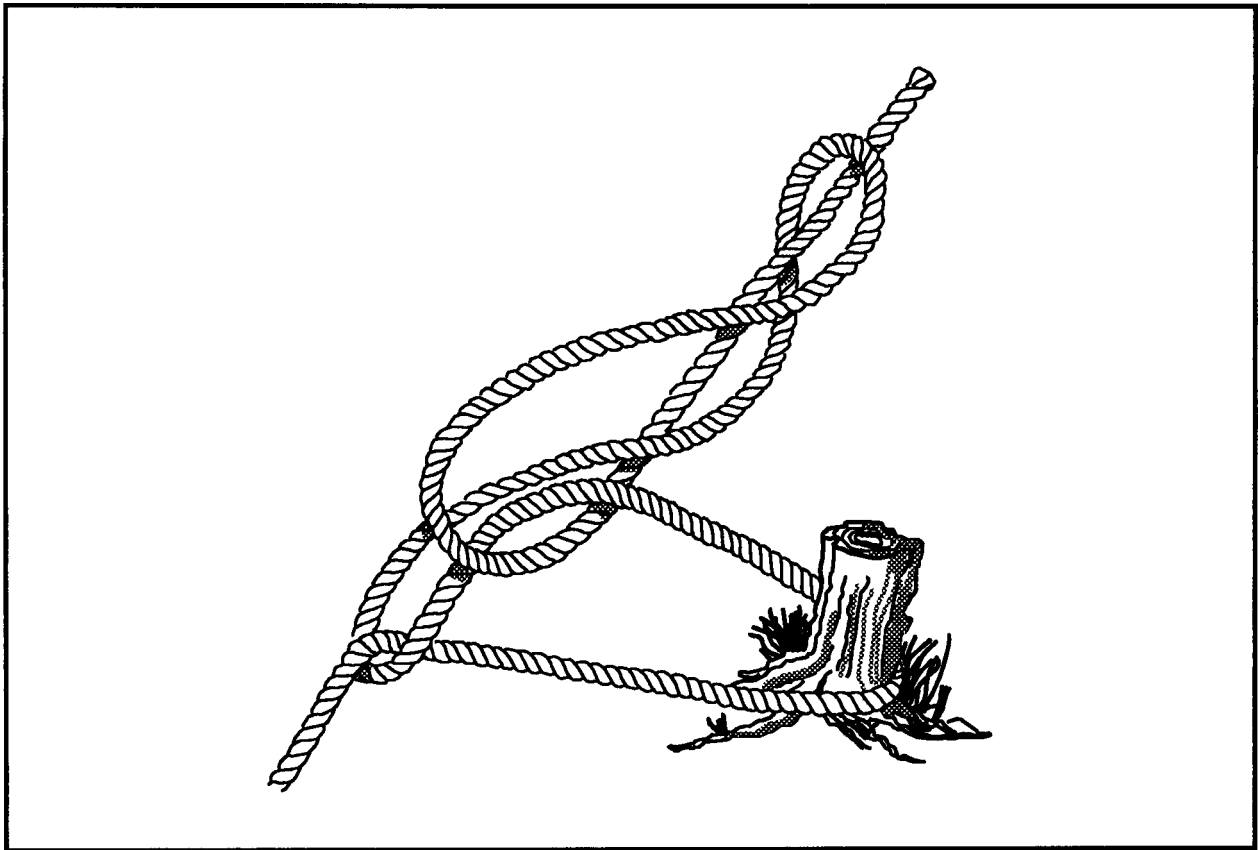

Figure 2-19. Figure eight with an extra turn

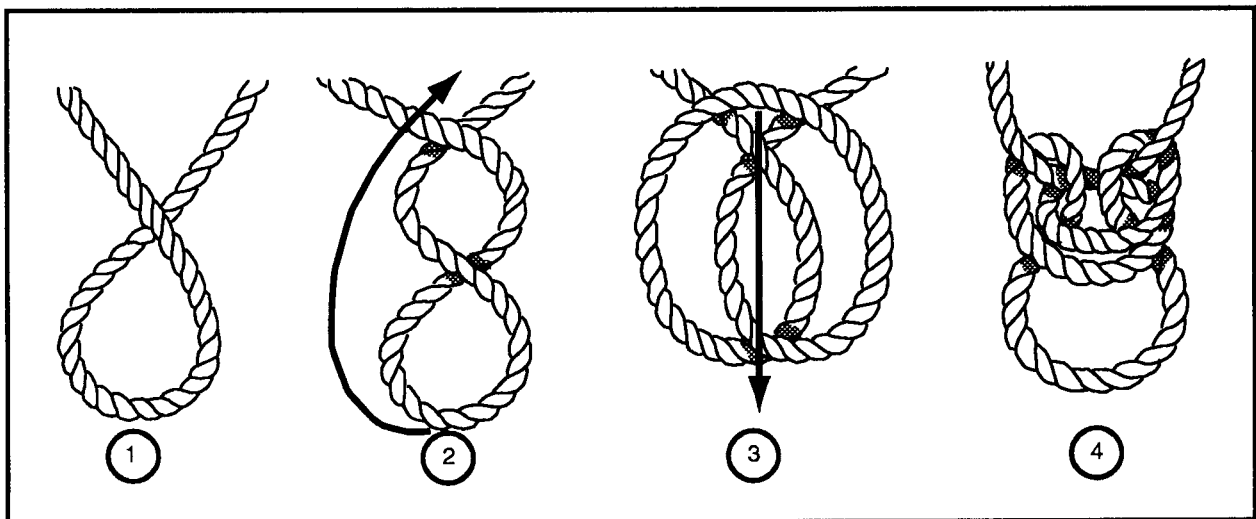

Figure 2-20. Butterfly knot

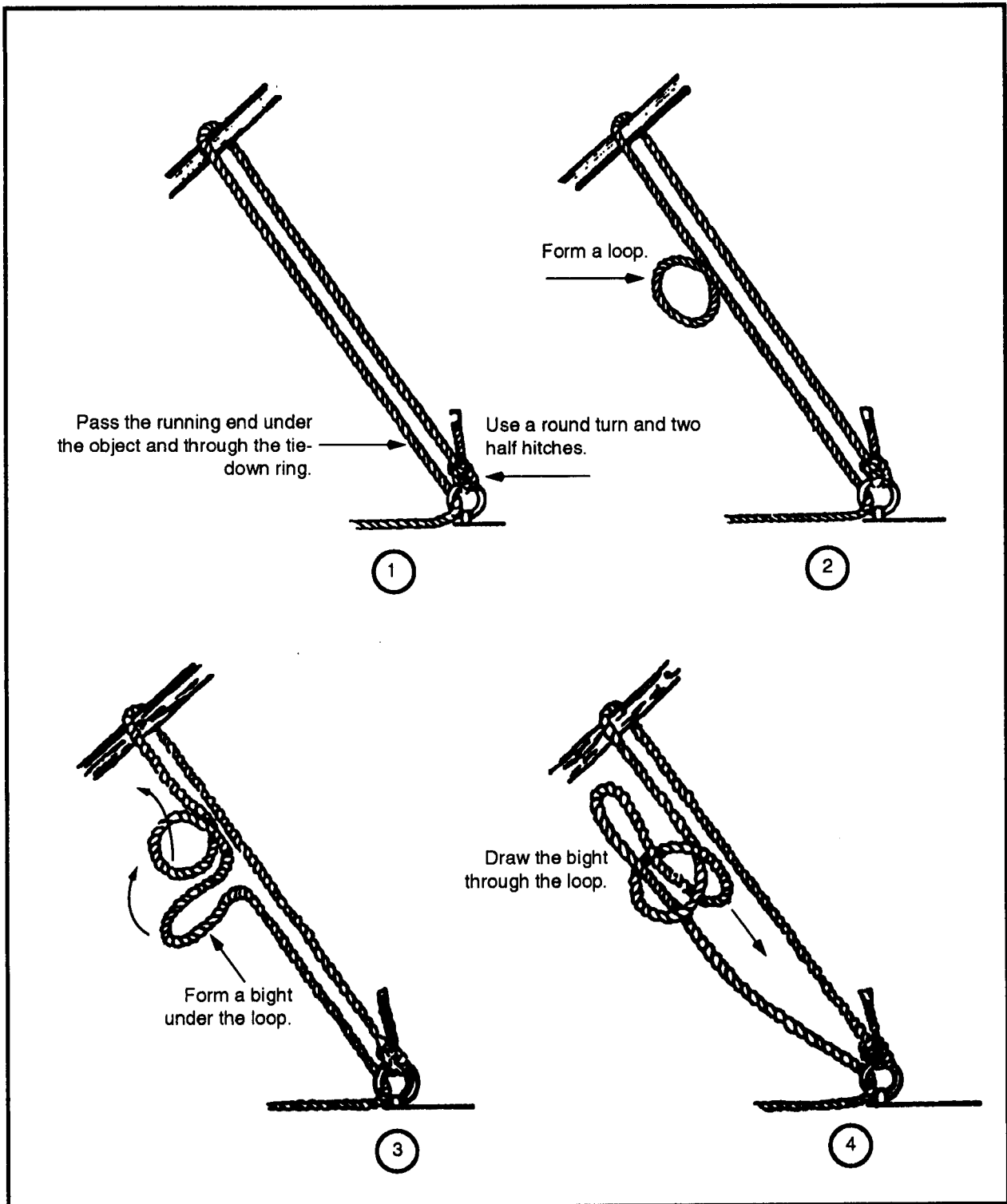

Figure 2-21. Baker bowline

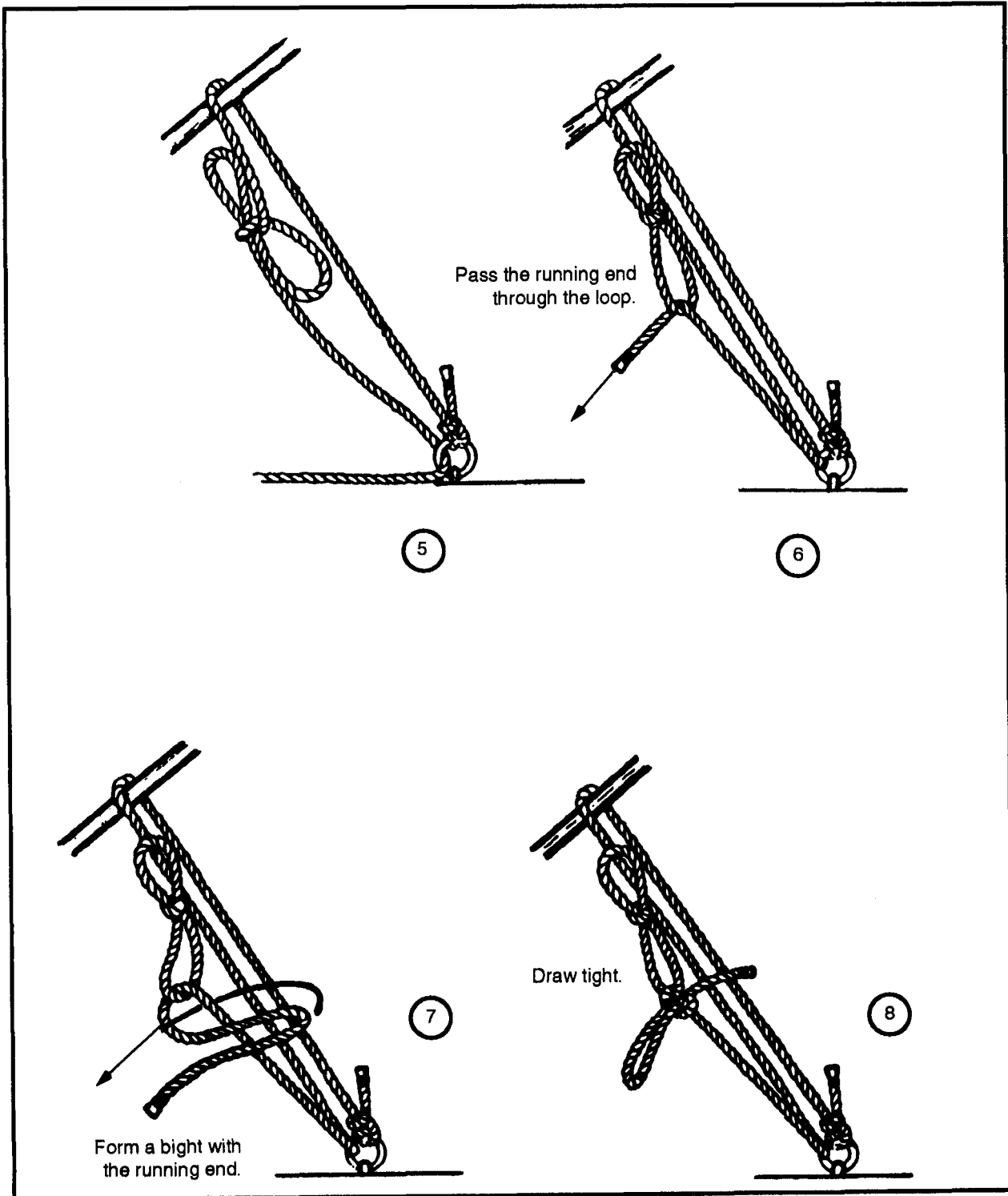

Figure 2-21. Baker bowline (continued)



wire or strands of cordage. Check all knots in wire rope periodically for wear or signs of breakage. If there is any reason to believe that the knot has been subjected to exces-

sive wear, cut off a short length of the end of the rope, including the knot, and tie a new knot. Use the fisherman's bend, clove hitch, and carrick bend to fasten wire rope.

## HITCHES

A hitch is any of various knots used to form a temporary noose in a rope or to secure a rope around a timber, pipe, or post so that it will hold temporarily but can be readily undone. The types of hitches are as follows:

- Half hitch.
- Two half hitches.
- Round turn and two half hitches.
- Timber hitch.
- Timber hitch and half hitch.
- Clove hitch.
- Rolling hitch.
- Telegraph hitch.
- Mooring hitch.
- Scaffold hitch.
- Blackwall hitch.
- Harness hitch.
- Girth hitch.

- Sheepshank.
- Fisherman's bend.

### HALF HITCH

Use the half hitch to tie a rope to a timber or to a larger rope (see *Figure 2-22, A*). It will hold against a steady pull on the standing part of the rope; however, it is not a secure hitch. You can use the half hitch to secure the free end of a rope and as an aid to and the foundation of many knots. For example, it is the start of a timber hitch and a part of the fisherman's knot. It also makes the rolling hitch more secure.

### TWO HALF HITCHES

Two half hitches are especially useful for securing the running end of a rope to the standing part (see *Figure 2-22, B*). If the two hitches are slid together along the standing part to form a single knot, the knot becomes a clove hitch.

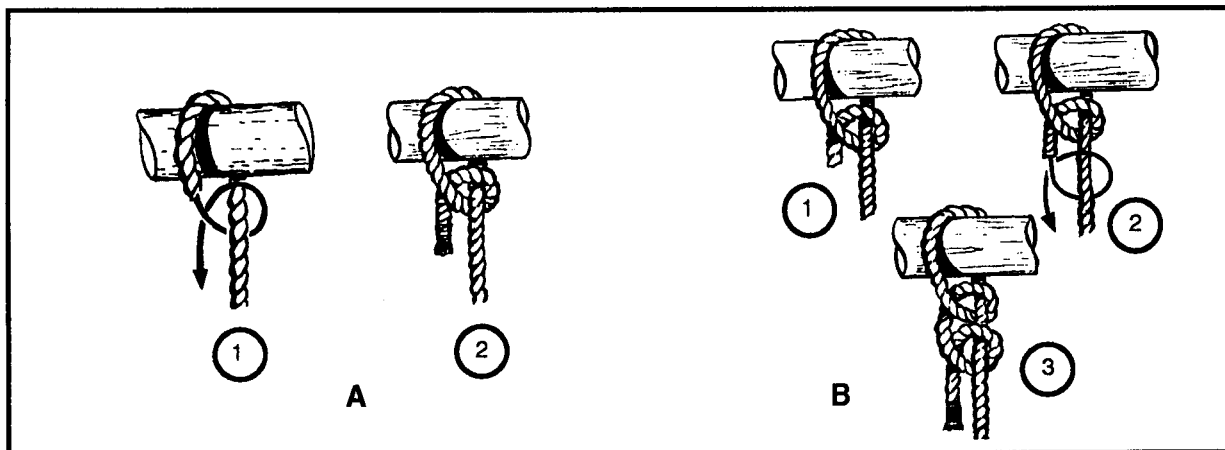

Figure 2-22. Half hitches

### ROUND TURN AND TWO HALF HITCHES

Another hitch used to fasten a rope to a pole, timber, or spar is the round turn and two half hitches (see *Figure 2-23*). For greater security, seize the running end of the rope to the standing part. This hitch does not jam.

### TIMBER HITCH

Use the timber hitch to move heavy timber or poles (see *Figure 2-24*). It is excellent for securing a piece of lumber or similar objects. The pressure of the coils, one over the other, holds the timber securely; the more tension applied, the tighter the hitch becomes about the timber. It will not slip but will readily loosen when the strain is relieved.

### TIMBER HITCH AND HALF HITCH

A timber hitch and half hitch are combined to hold heavy timber or poles when they are being lifted or dragged (see *Figure 2-25*). A timber hitch used alone may become untied when the rope is slack or when a sudden strain is put on it.

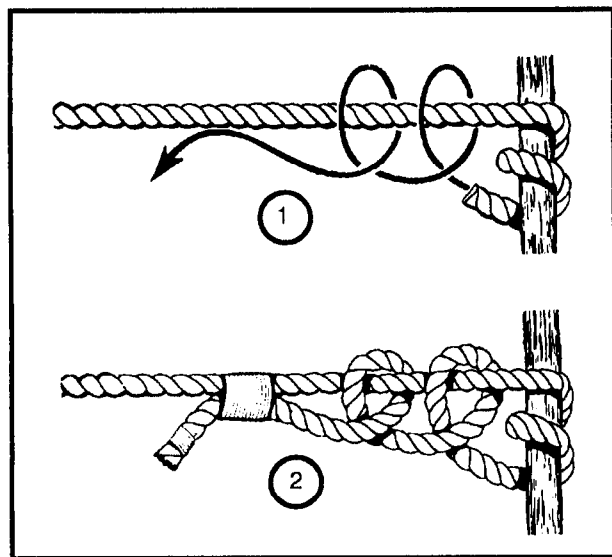

Figure 2-23. Round turn and two half hitches

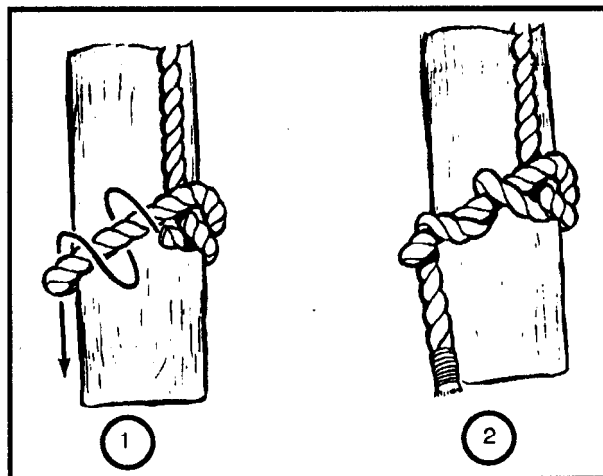

Figure 2-24. Timber hitch

### CLOVE HITCH

The clove hitch is one of the most widely used knots (see *Figure 2-26*, page 2-19). You can use it to fasten a rope to a timber, pipe, or post. You can also use it to make other knots. This knot puts very little strain on the fibers when the rope is put around an object in one continuous direction. You can tie a clove hitch at any point in a rope. If there is not constant tension on the rope, another loop (round of the rope around the object and under the center of the clove hitch) will permit a tightening and slackening motion of the rope.

### ROLLING HITCH

Use the rolling hitch to secure a rope to another rope or to fasten it to a pole or pipe

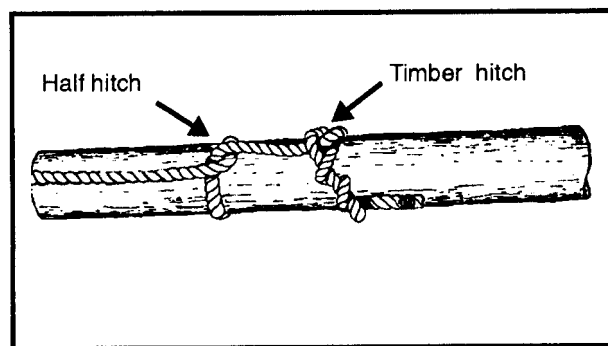

Figure 2-25. Timber hitch and half hitch

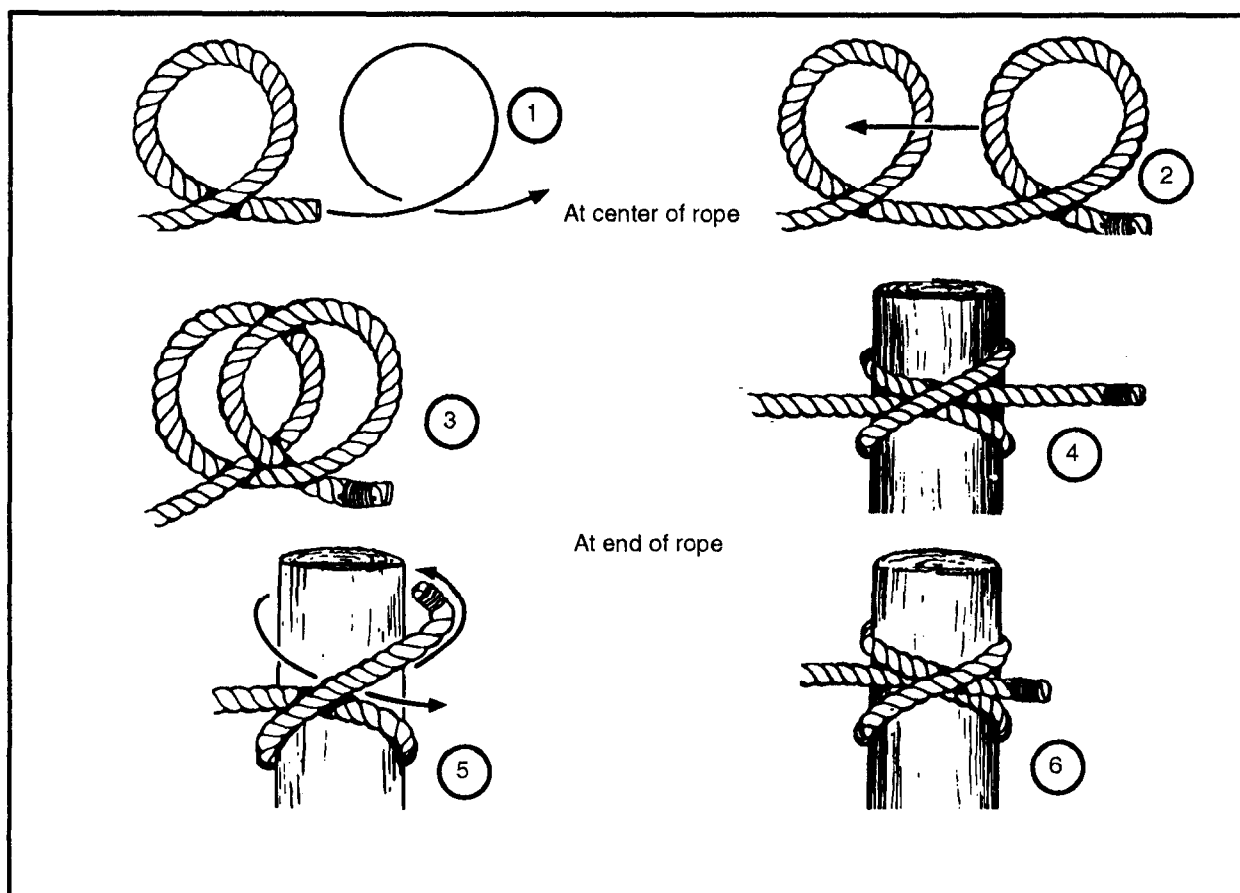

Figure 2-26. Clove hitch

so that the rope will not slip (see *Figure 2-27, page 2-20*). This knot grips tightly but is easily moved along a rope or pole when the strain is relieved.

#### TELEGRAPH HITCH

The telegraph hitch is a very useful and secure hitch that you can use to hoist or haul posts and poles (see *Figure 2-28, page 2-20*). It is easy to tie and untie and will not slip.

#### MOORING HITCH

Use the mooring hitch, also called rolling or magnus hitch, to fasten a rope around a mooring post or to attach a rope at a right angle to a post (see *Figure 2-29, page 2-21*).

This hitch grips tightly and is easily removed.

#### SCAFFOLD HITCH

Use the scaffold hitch to support the end of a scaffold plank with a single rope (see *Figure 2-30, page 2-21*). It prevents the plank from tilting.

#### BLACKWALL HITCH

Use the blackwall hitch to fasten a rope to a hook (see *Figure 2-31, page 2-22*). Generally, use it to attach a rope, temporarily, to a hook or similar object in derrick work. The hitch holds only when subjected to a constant strain or when used in the middle of a

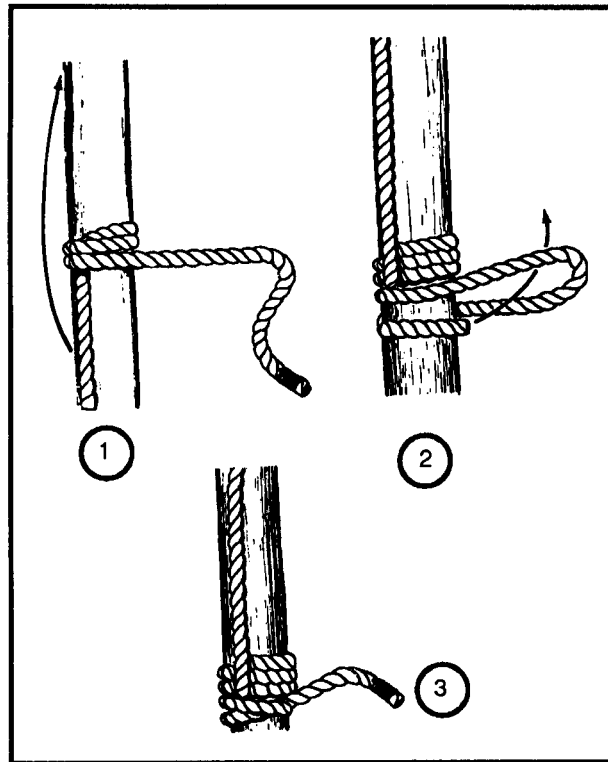

Figure 2-27. Rolling hitch

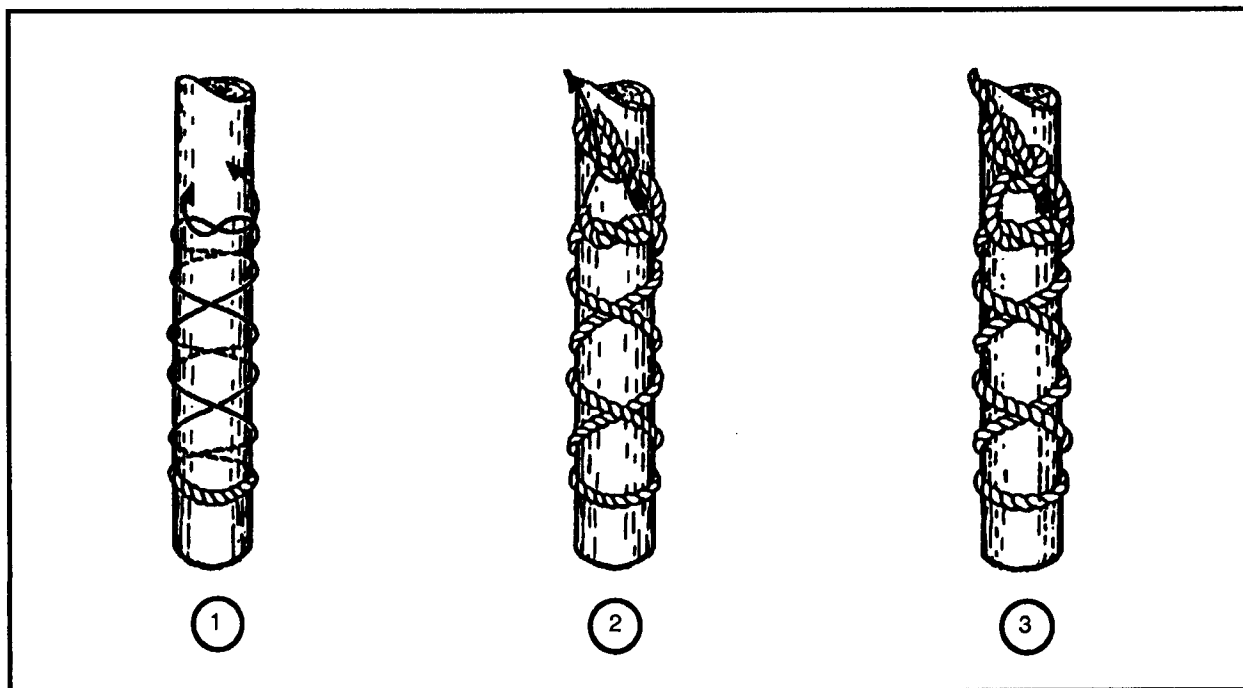

Figure 2-28. Telegraph hitch

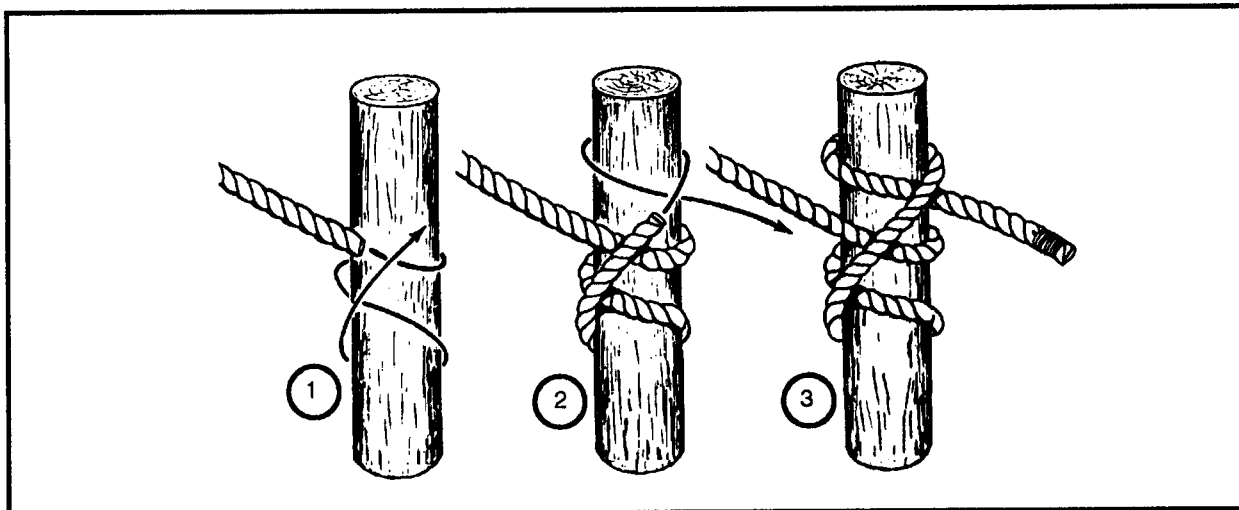

Figure 2-29. Mooring hitch

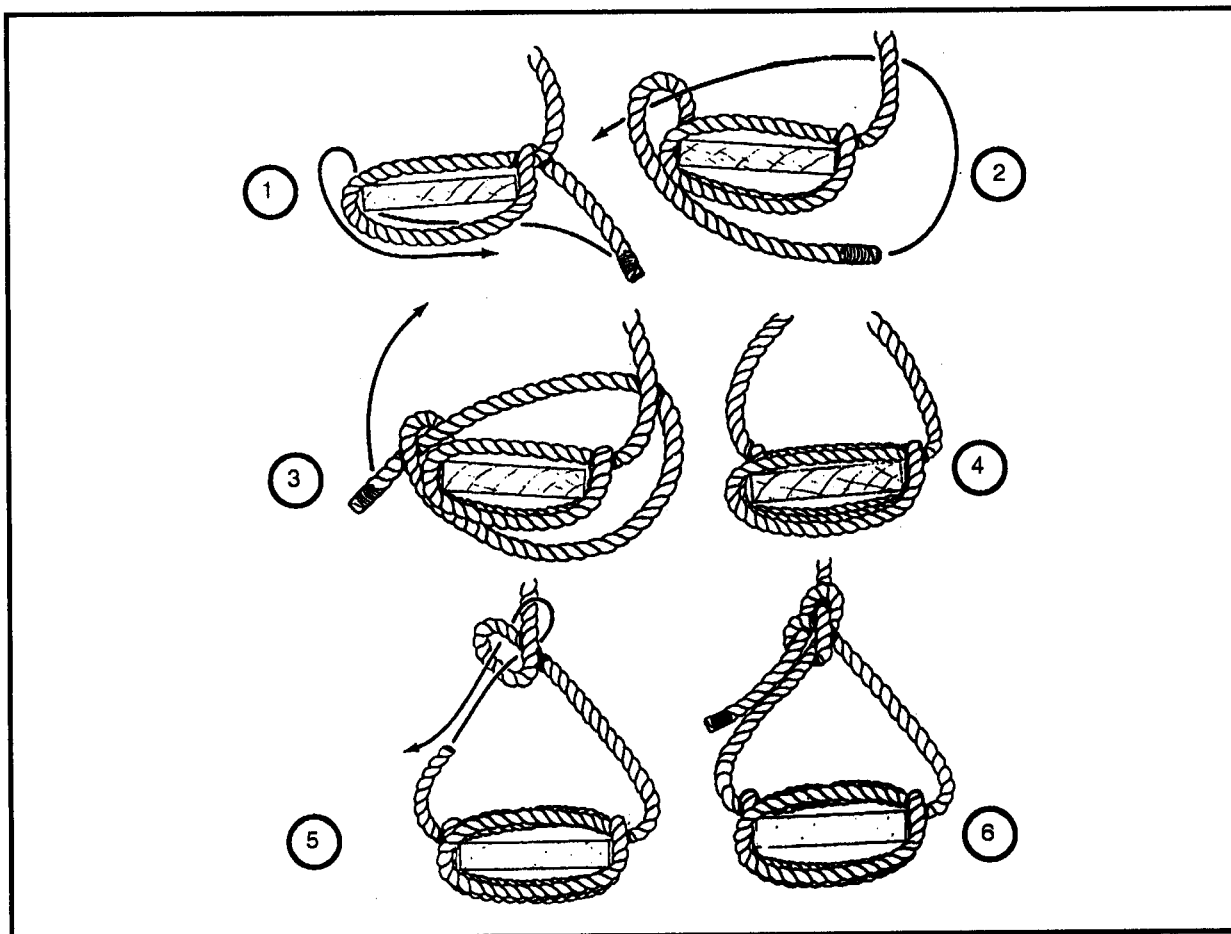

Figure 2-30. Scaffold hitch

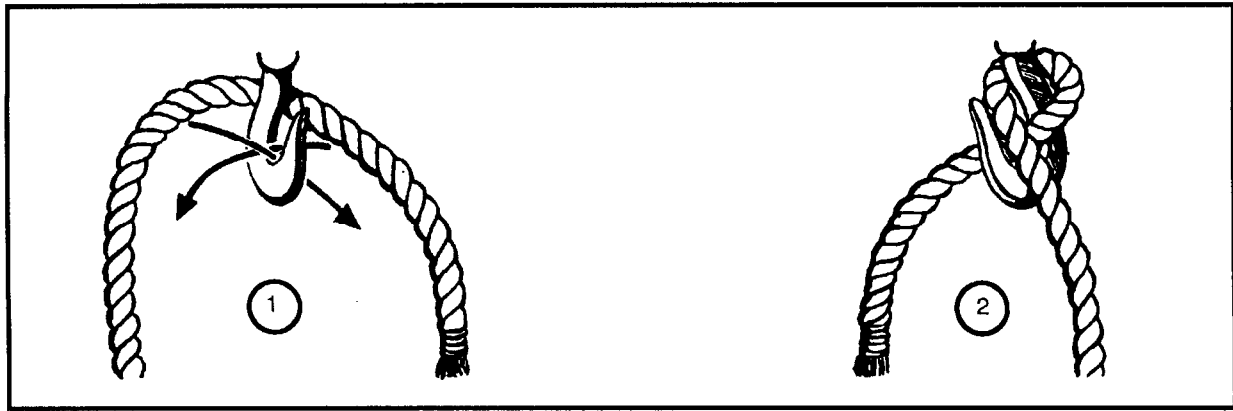

Figure 2-31. Blackwall hitch

rope with both ends secured. Human life and breakable equipment should never be entrusted to the blackwall hitch.

The hitch is tied only in the middle of a rope. It will slip if only one end of the rope is pulled.

**HARNES HITCH**

The harness hitch forms a nonslipping loop in a rope (see *Figure 2-32*). It is often employed by putting an arm through the loop, then placing the loop on the shoulder and pulling the object attached to the rope.

**GIRTH HITCH**

Use the girth hitch to tie suspender ropes to hand ropes when constructing expedient foot bridges (see *Figure 2-33*). It is a simple and convenient hitch for many other uses of ropes and cords.

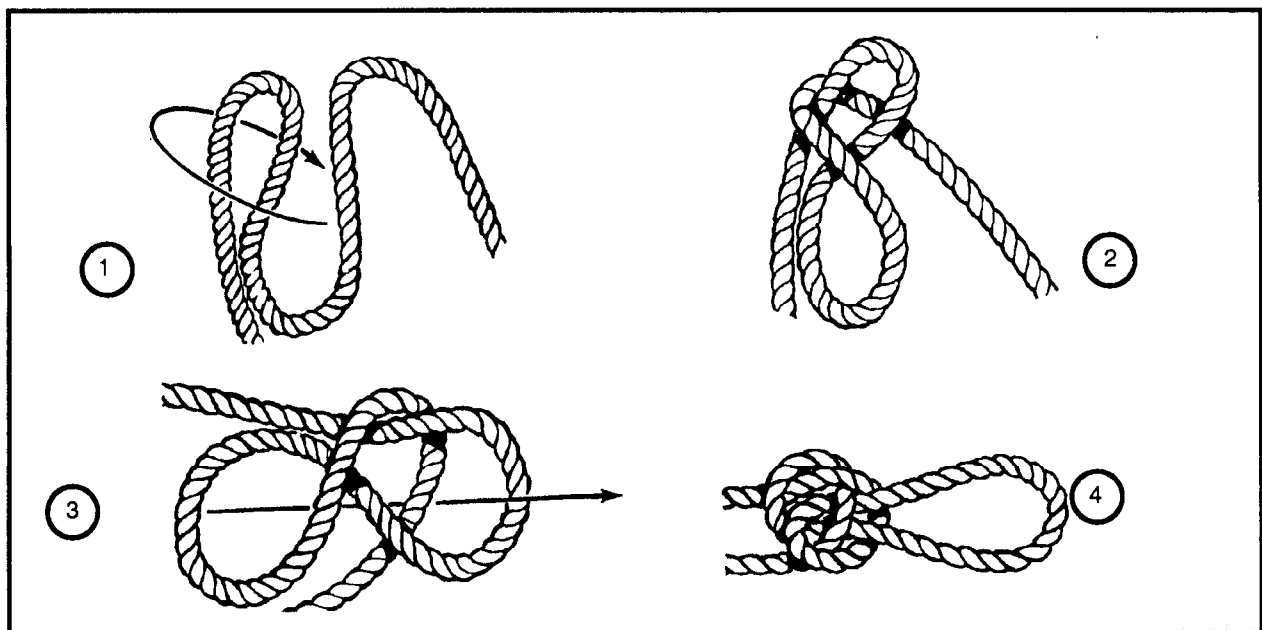

Figure 2-32. Harness hitch

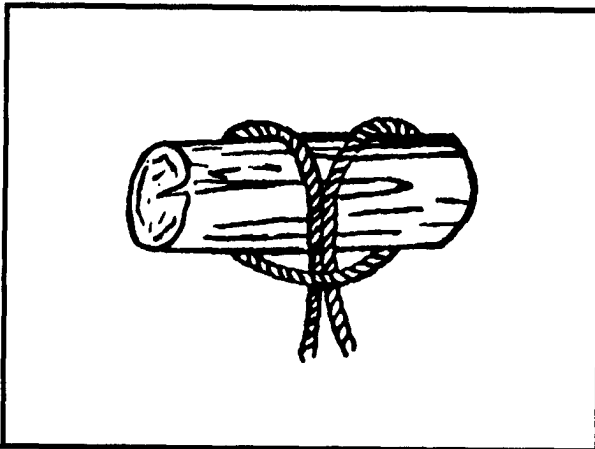

Figure 2-33. Girth hitch

### SHEEPSHANK

A sheepshank is a method of shortening a rope, but you can use it to take the load off a weak spot in the rope (see *Figure 2-34*). It is only a temporary knot unless the eyes are fastened to the standing part on each end.

### FISHERMAN'S BEND

The fisherman's bend is an excellent knot for attaching a rope to a light anchor, a ring, or a rectangular piece of stone (see *Figure 2-35, page 2-24*). You can use it to fasten a rope or cable to a ring or post. Also use it where there will be a slackening and tightening motion in the rope.

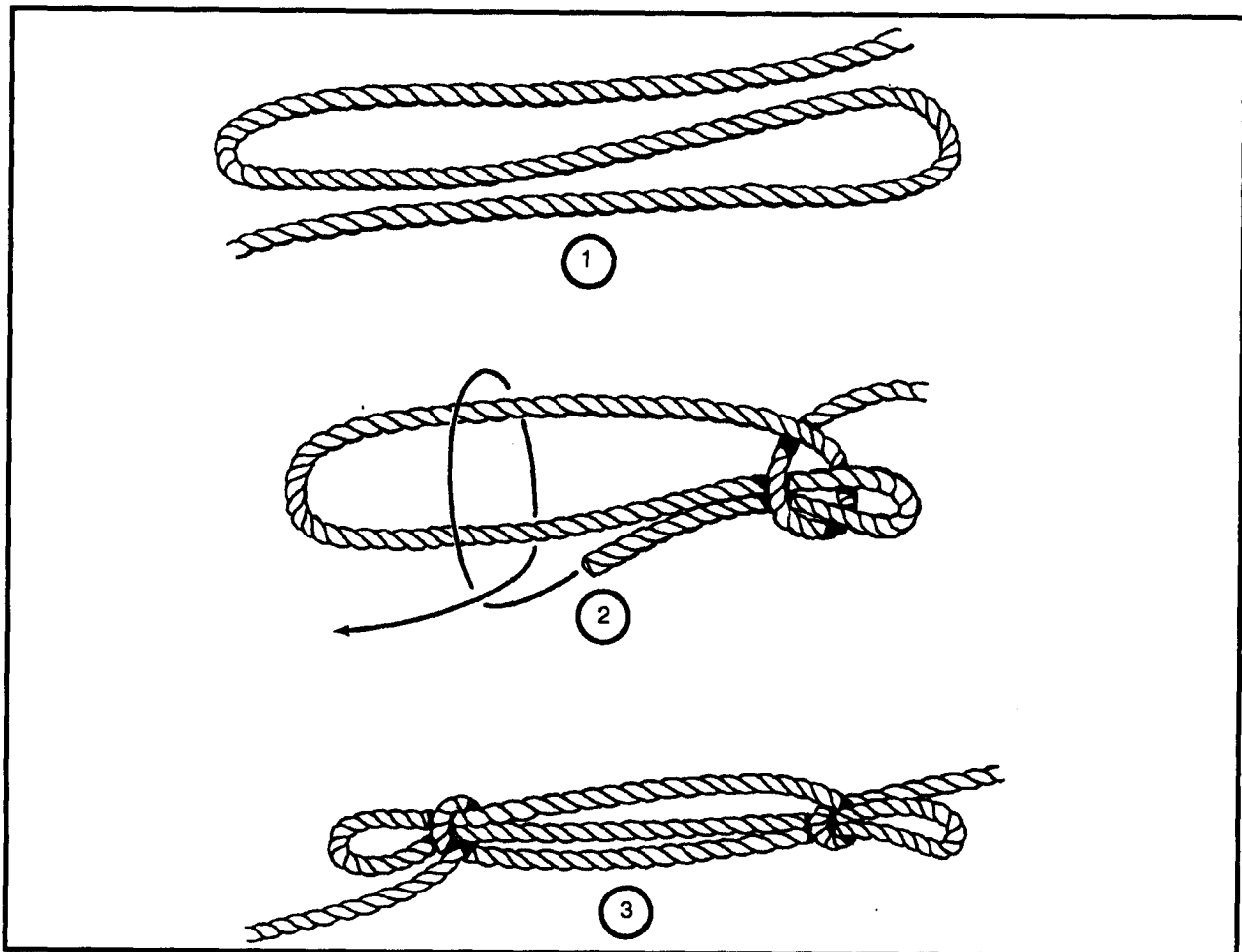

Figure 2-34. Sheepshank

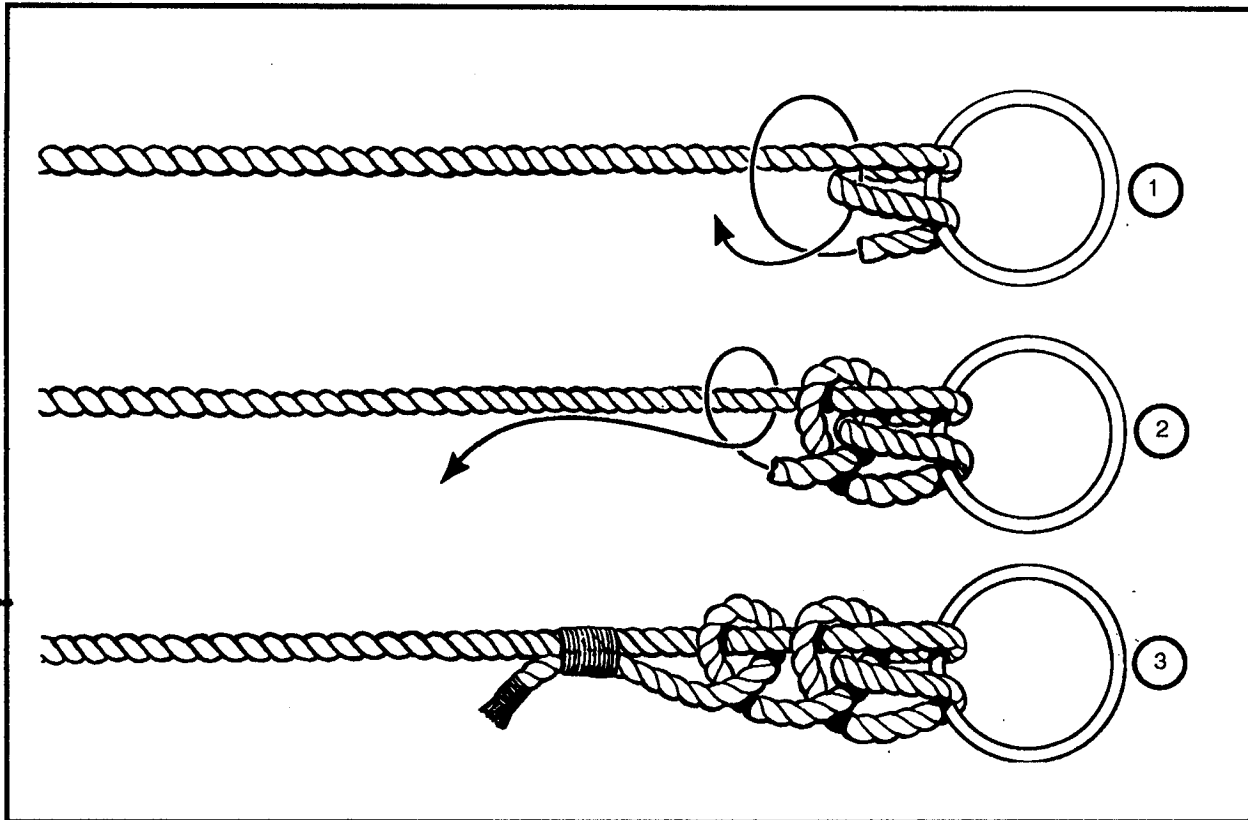

Figure 2-35. Fisherman's bend

## LASHINGS

A lashing is as rope, wire, or chain used for binding, wrapping, or fastening. The types of lashings include square, shears, and block.

### SQUARE LASHING

Use the square lashing to lash two spars together at right angles to each other (see *Figure 2-36*). To tie a square lashing, begin with a clove hitch on one spar and make a minimum of four complete turns around both members. Continue with two frapping turns between the vertical and the horizontal spar to tighten the lashing. Tie off the running end to the opposite spar from which you started with another clove hitch to finish the square lashing.

### SHEARS LASHING

Use the shears lashing to lash two spars together at one end to form an expedient device called a shears (see *Figure 2-37*). Do this by laying two spars side by side, spaced about one-third of the diameter of a spar apart, with the butt ends together. Start the shears lashing a short distance in from the top of one of the spars by tying the end of the rope to it with a clove hitch. Then make eight tight turns around both spars above the clove hitch. Tighten the lashing with a minimum of two frapping turns around the eight turns. Finish the shears lashing by tying the end of the rope to the opposite spar from which you started with another clove hitch.



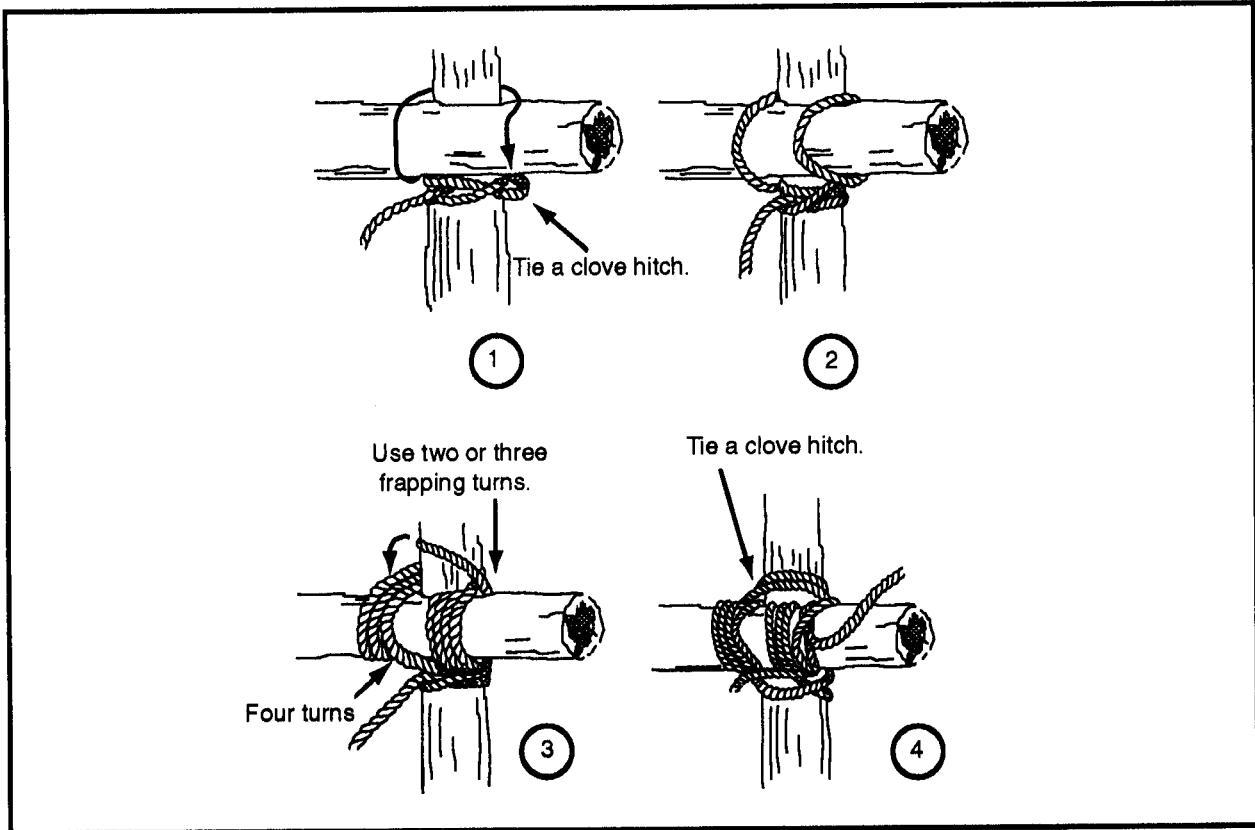

Figure 2-36. Square lashing

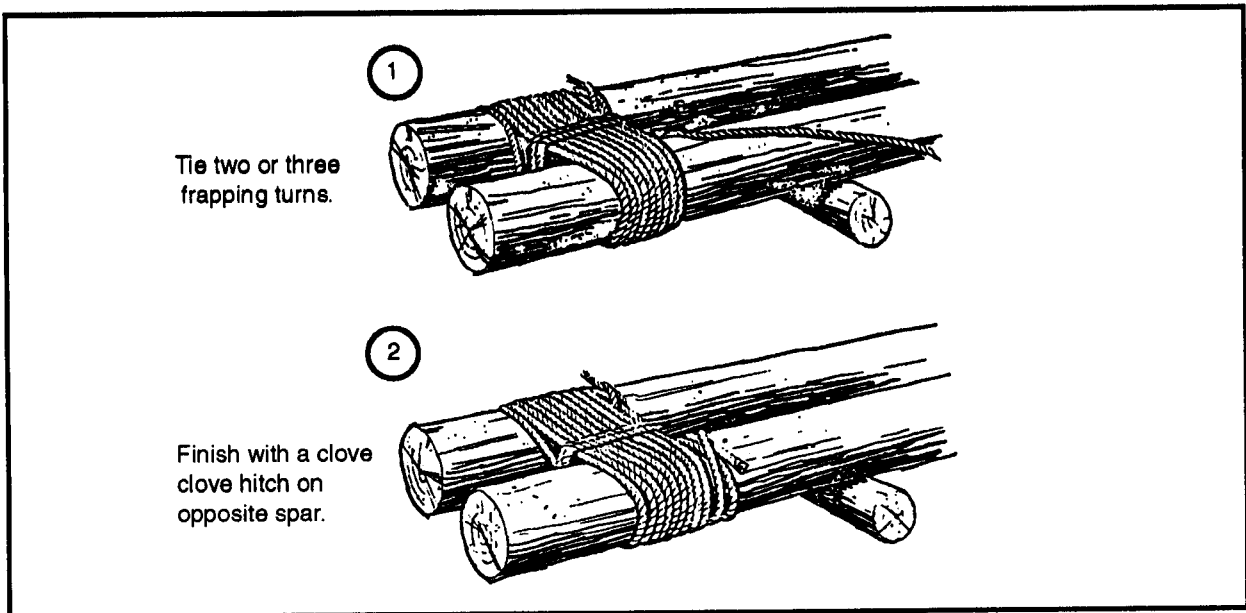
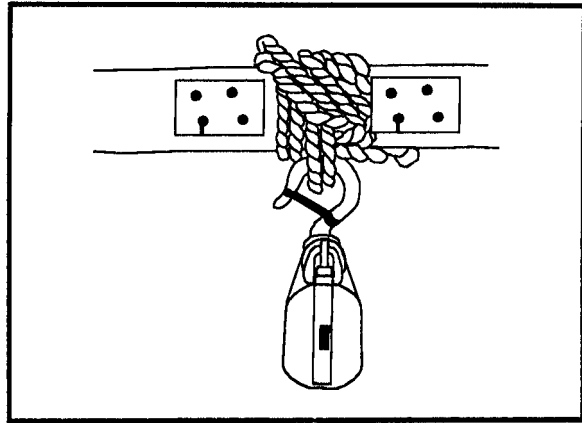

Figure 2-37. Shears lashing

### BLOCK LASHING

Use the block lashing to tie a tackle block to a spar (see *Figure 2-38*). First, make three right turns of the rope around the spar where the tackle block is to be attached. Pass the next two turns of the rope through the mouth of the hook or shackle of the tackle block and drawn tightly. Then put three additional taut turns of the rope around the spar above the hook or shackle. Complete the block lashing by tying the two ends of the rope together with a square knot. When a sling is supported by a block lashing, pass the sling through the center four turns.



**Figure 2-38. Block lashing**

## Section II. Splices

Splicing is a method of joining fiber or wire rope by unlaying strands of both ends and interweaving these strands together. The general types of splices are—

- A short splice.
- An eye or side splice.
- A long splice.
- A crown or back splice.

The methods of making all four types of splices are similar. They generally consist of the following basic steps—

- Unlaying the strands of the rope.
- Placing the rope ends together.
- Interweaving the strands and tucking them into the rope.

### FIBER-ROPE SPLICES

When one strand of a rope is broken, you cannot repair it by tying the ends together because this would shorten the strand. Repair it by inserting a strand longer than the break and tying the ends together (see *Figure 2-39*).

#### SHORT SPLICE

The short splice is as strong as the rope in which it is made and will hold as much as a long splice (see *Figure 2-40*). However, the short splice causes an increase in the diameter of the rope for a short distance and can be used only where this increase in diameter will not affect operations. It is called the

short splice because a minimum reduction in rope length takes place in making the splice. This splice is frequently used to repair damaged ropes when two ropes of the same size are to be joined together permanently. Cut out the damaged parts of the rope and splice the sound sections.

#### EYE OR SIDE SPLICE

Use the eye or side splice to make a permanent loop in the end of a rope (see *Figure 2-41, page 2-28*). You can use the loops, made with or without a thimble, to fasten the rope to a ring or hook. Use a thimble to reduce wear. Use this splice also to splice

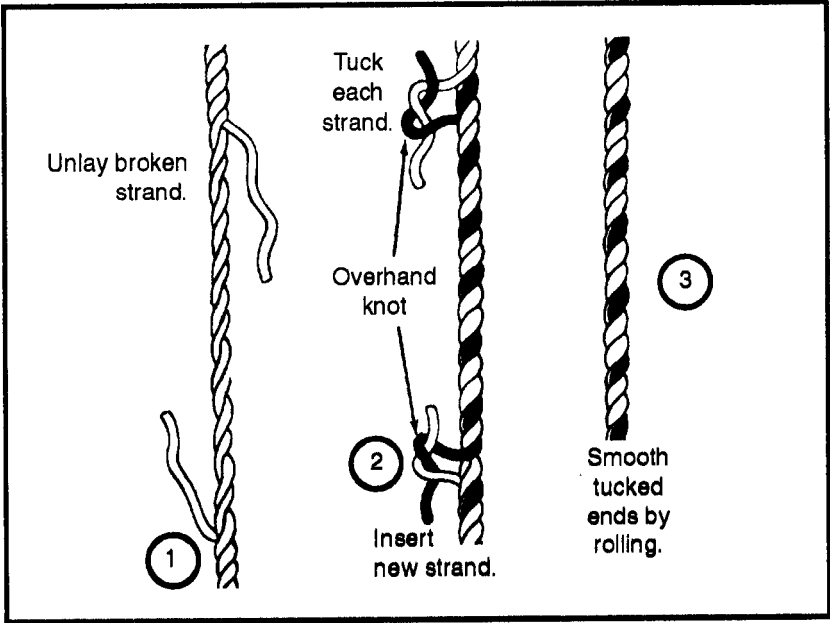

Figure 2-39. Renewing rope strands

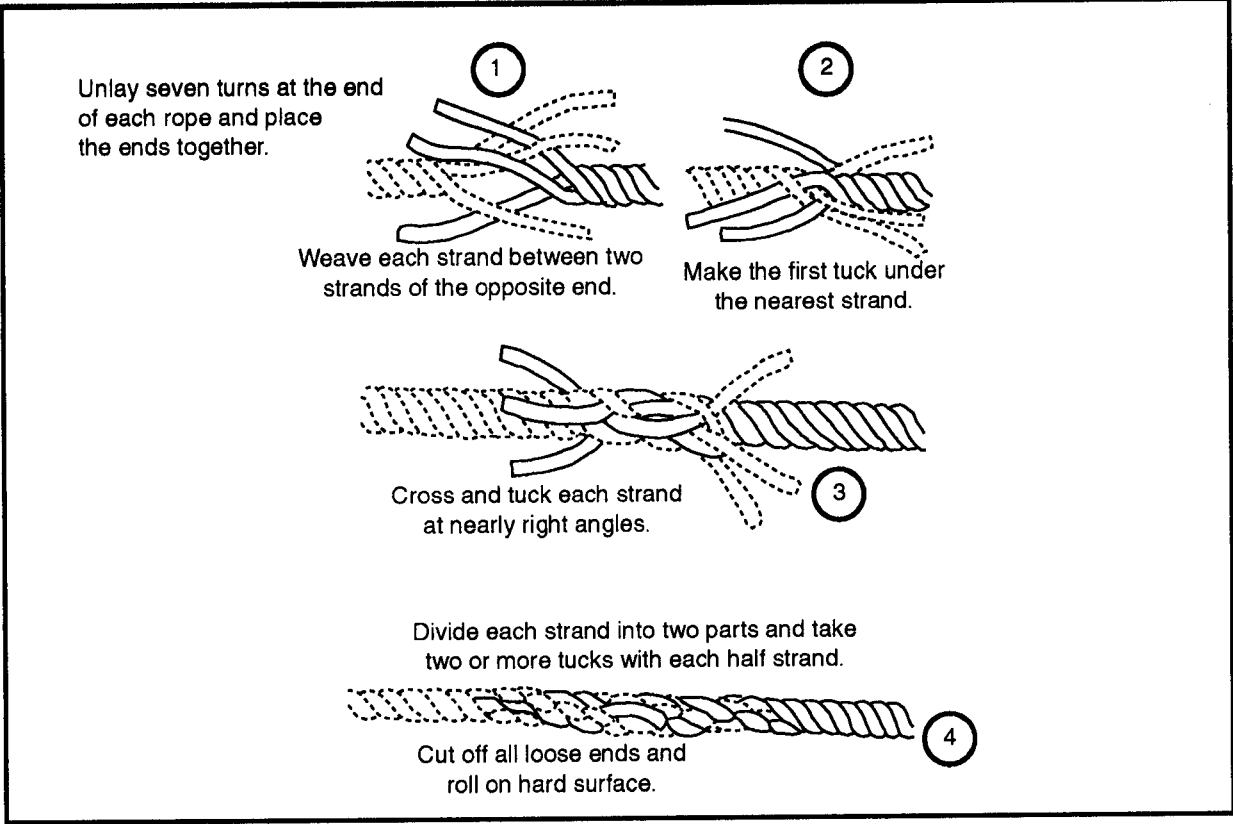
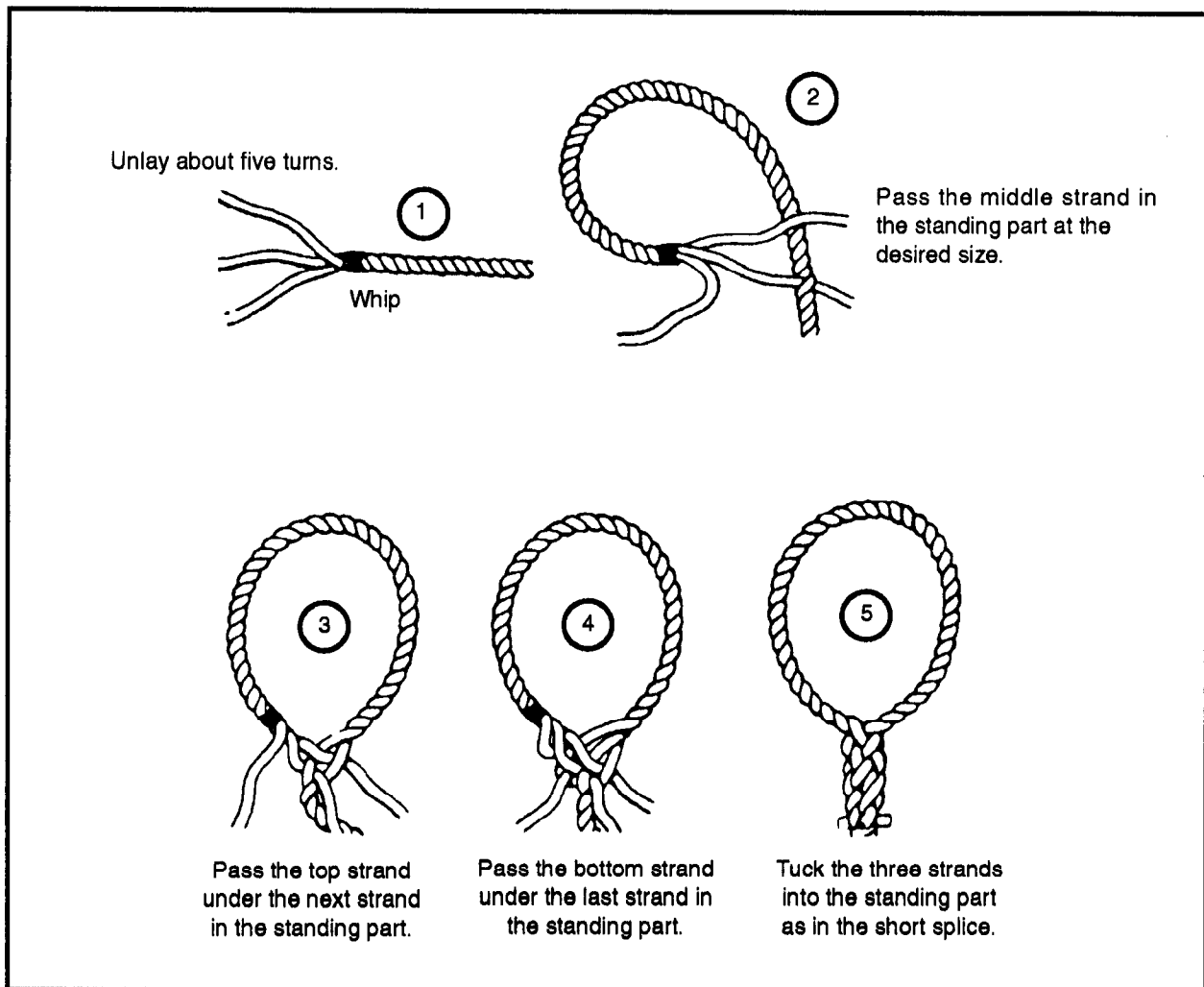

Figure 2-40. Short splice for fiber rope



**Figure 2-41. Eye or side splice for fiber rope**

one rope into the side of another. As a permanent loop or eye, no knot can compare with this splice for neatness and efficiency.

The ropes to be joined should be the same lay and as nearly the same diameter as possible.

### LONG SPLICE

Use the long splice when the larger diameter of the short splice has an adverse effect on the use of the rope; use it also to splice long ropes that operate under heavy stress (see *Figure 2-42*). This splice is as strong as the rope itself. A skillfully made long splice will run through sheaves without any difficulty.

### CROWN OR BACK SPLICE

When you are splicing the end of a rope to prevent unlaying, and a slight enlargement of the end is not objectionable, use a crown splice to do this (see *Figure 2-43, page 2-30*). Do not put any length of rope into service without properly preparing the ends.

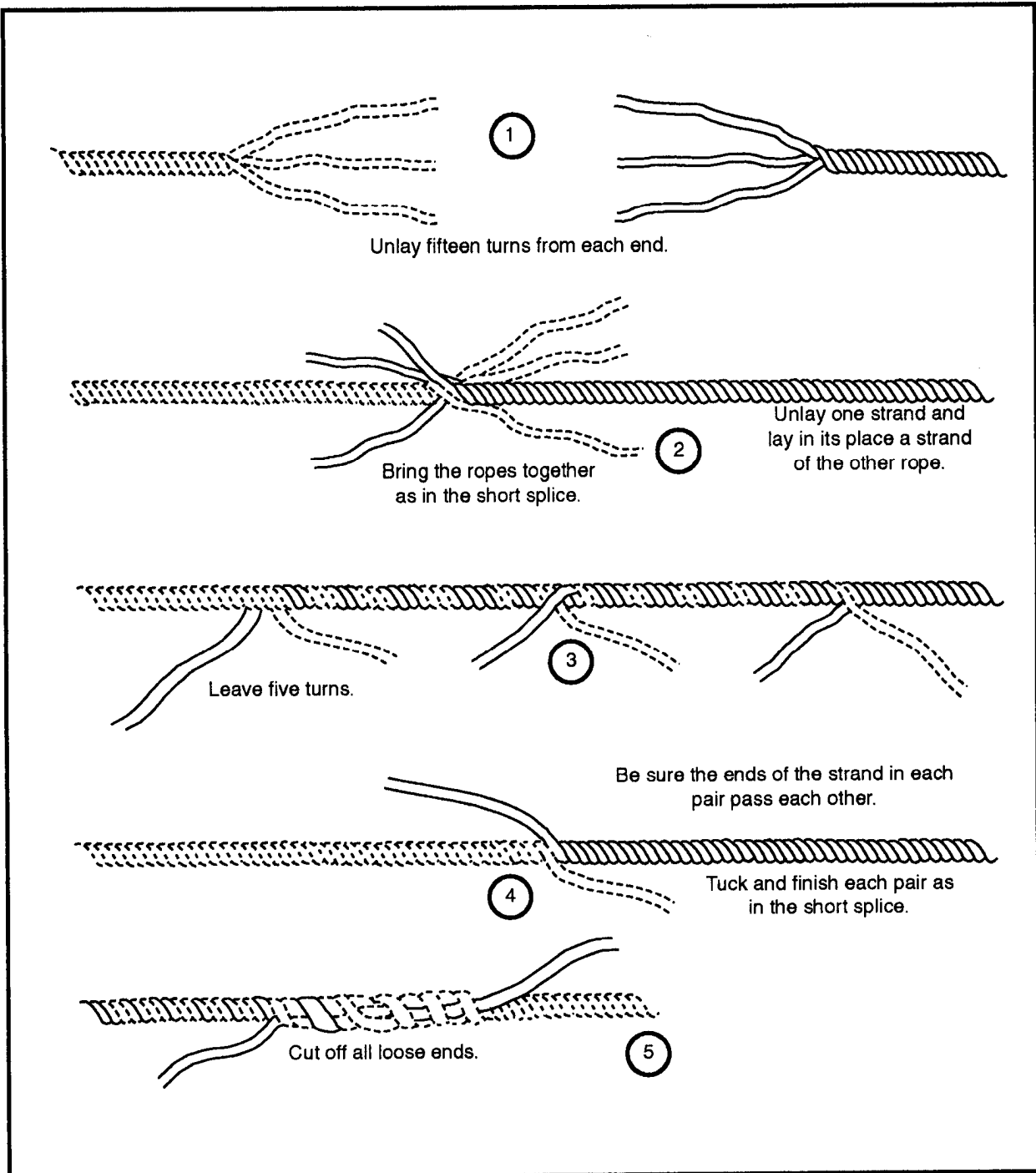

Figure 2-42. Long splice for fiber rope

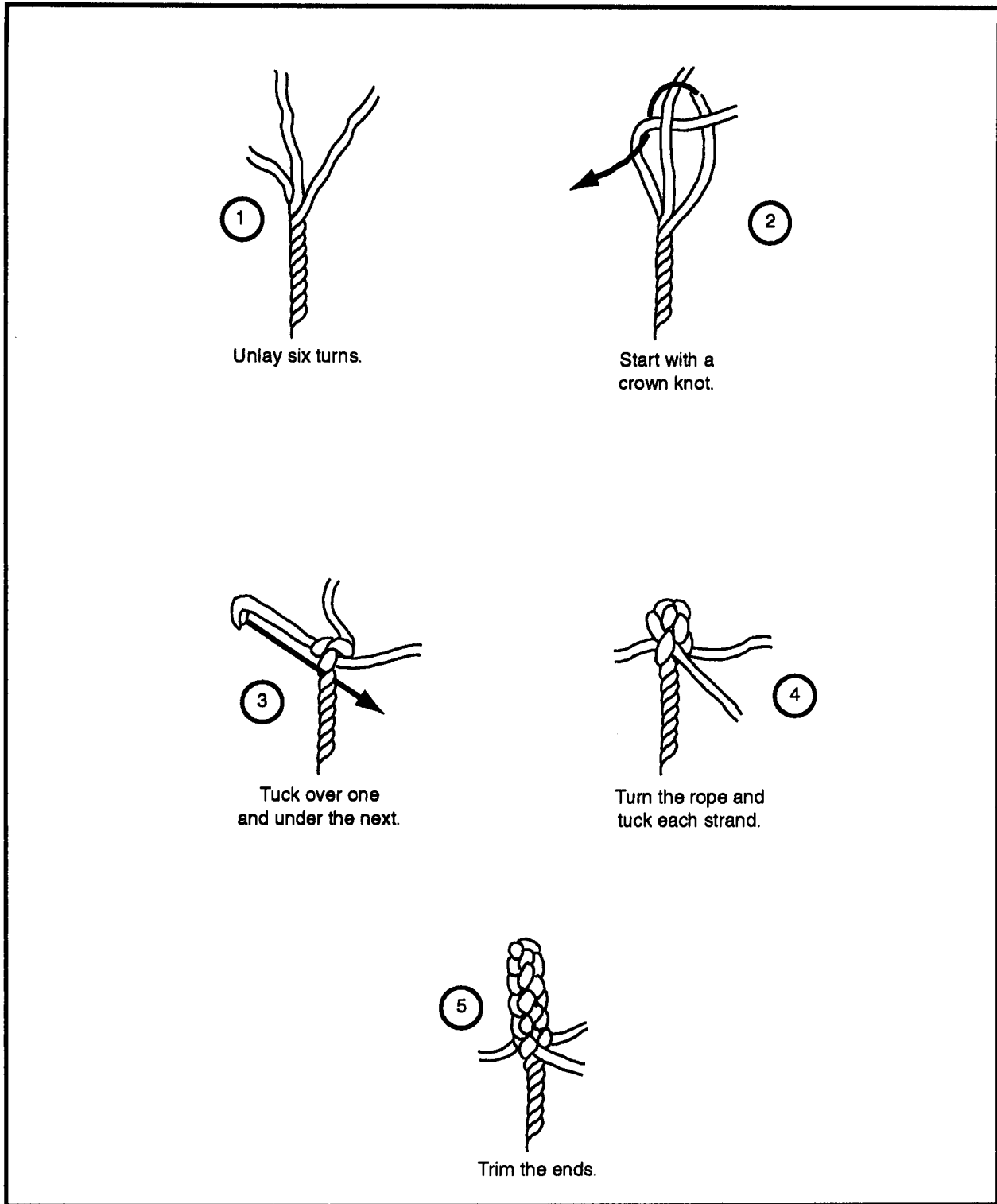

Figure 2-43. Crown or back splice for fiber rope

## WIRE-ROPE SPLICES

In splicing wire rope, it is extremely important to use great care in laying the various rope strands firmly into position. Slack strands will not receive their full share of the load, which causes excessive stress to be put on the other strands. The unequal stress distribution will decrease the possible ultimate strength of the splice. When using splices in places where their failure may result in material damage or may endanger human lives, test the splices under stresses equal to at least twice their maximum working load before placing the ropes into service. Table 2-2 shows the amount or length of rope to be unlaidd on each of the two ends of the ropes and the amount of tuck for ropes of different diameters. As a rule of thumb, use the following:

- Long splice, 40 times the diameter.
- Short splice, 20 times the diameter.

You need only a few tools to splice wire rope. In addition to the tools shown in *Figure 2-44, page 2-32*, a hammer and cold chisel are often used to cut the ends of strands. Use two slings of marline and two sticks to

untwist the wire. A pocket knife may be needed to cut the hemp core.

### SHORT SPLICE

A short splice develops only from 70 to 90 percent of the strength of the rope. Since a short splice is bulky, it is used only for block straps, slings, or where an enlargement of the diameter is of no importance. It is not suitable for splicing driving ropes or ropes used in running tackles and should never be put into a crane or hoist rope. The wire rope splice differs from the fiber rope short splice only in the method by which the end strands are tucked (see *Figure 2-45, page 2-32*).

### EYE OR SIDE SPLICE

An eye splice can be made with or without a thimble. Use a thimble for every rope eye unless special circumstances prohibit it (see *Figure 2-46, page 2-33*). The thimble protects the rope from sharp bends and abrasive action. The efficiency of a well-made eye splice with a heavy-duty thimble varies

**Table 2-2. Amount of wire rope to allow for splices and tucks**

Diameter (inches)	Length of Rope to Allow (feet)			Tuck Length (inches)		
	Short Splice	Eye Splice	Long Splice	Short Splice	Eye Splice	Long Splice
1/4-3/8	15	1	30	15	1	30
1/2 - 5/8	20	2	40	20	2	40
3/4 - 7/8	24	2 1/2	50	24	2 1/2	50
1 -1 1/8	28	3	60	28	3	60
1 1/4 - 1 3/8	32	3 1/2	70	32	3 1/2	70
1 1/2	36	4	80	36	4	80

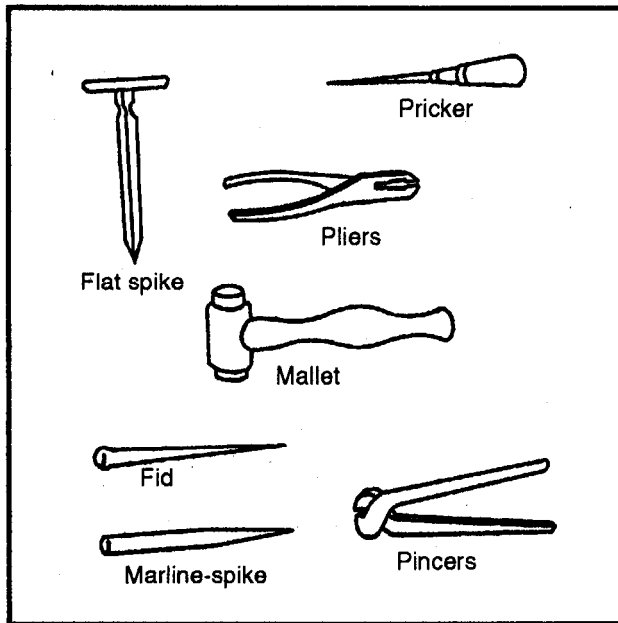

Figure 2-44. Tools for wire splicing

from 70 to 90 percent. Occasionally, it becomes necessary to construct a field expedient, called a hasty eye (see *Figure 2-47*). The hasty eye can be easily and quickly made but is limited to about 70 percent of the strength of the rope; consequently, it should not be used to hoist loads.

**LONG SPLICE**

Use the long splice to join two ropes or to make an endless sling without increasing the thickness of the wire rope at the splice (see *Figure 2-48, page 2-34*). It is the best and most important kind of splice because it is strong and trim.

**Round-Strand, Regular-Lay Rope**

The directions given in *Figure 2-48* are for making a 30-foot splice in a three-fourths

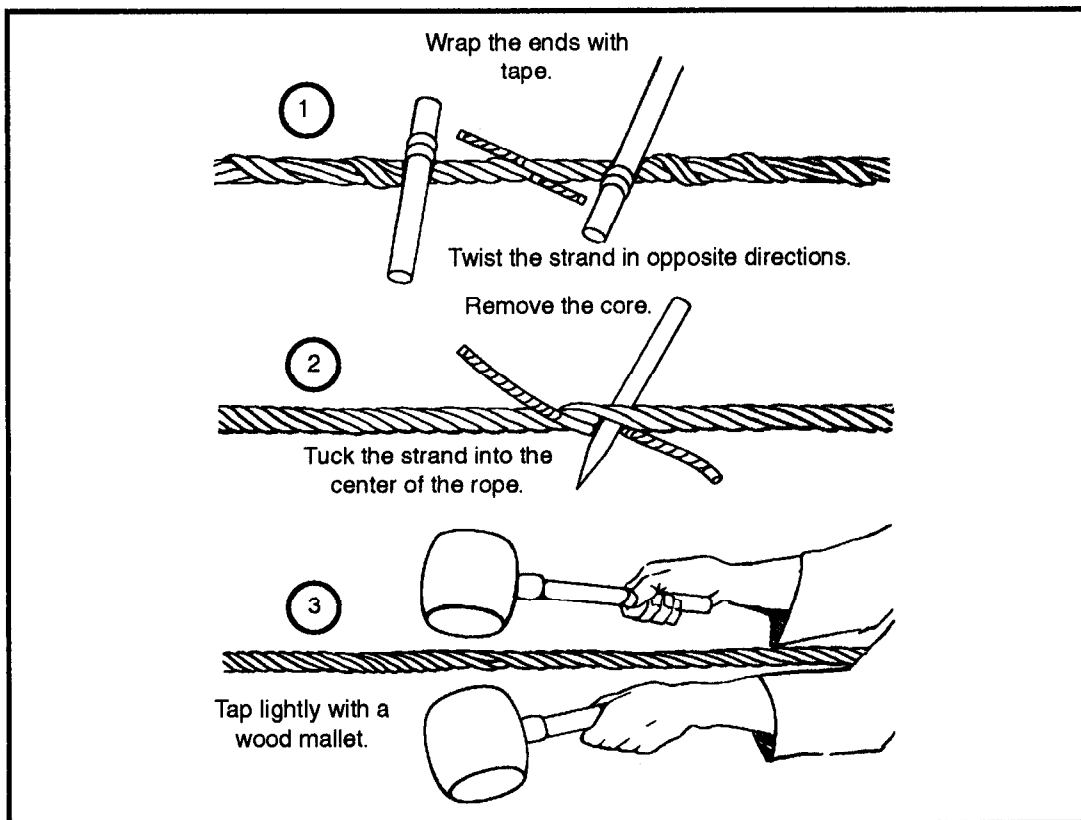

Figure 2-45. Tucking wire-rope strands



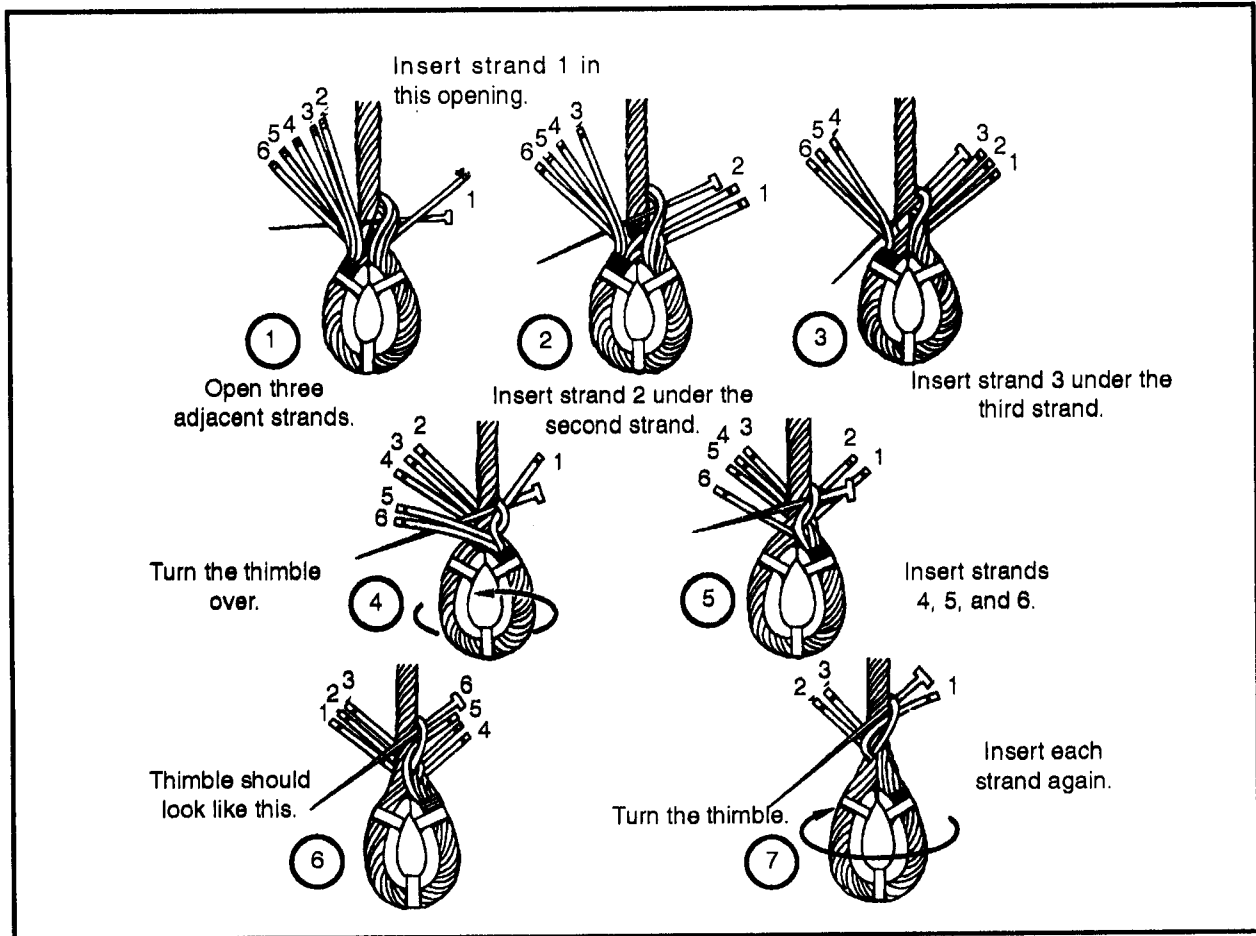

Figure 2-46. Eye splice with thimble for wire rope

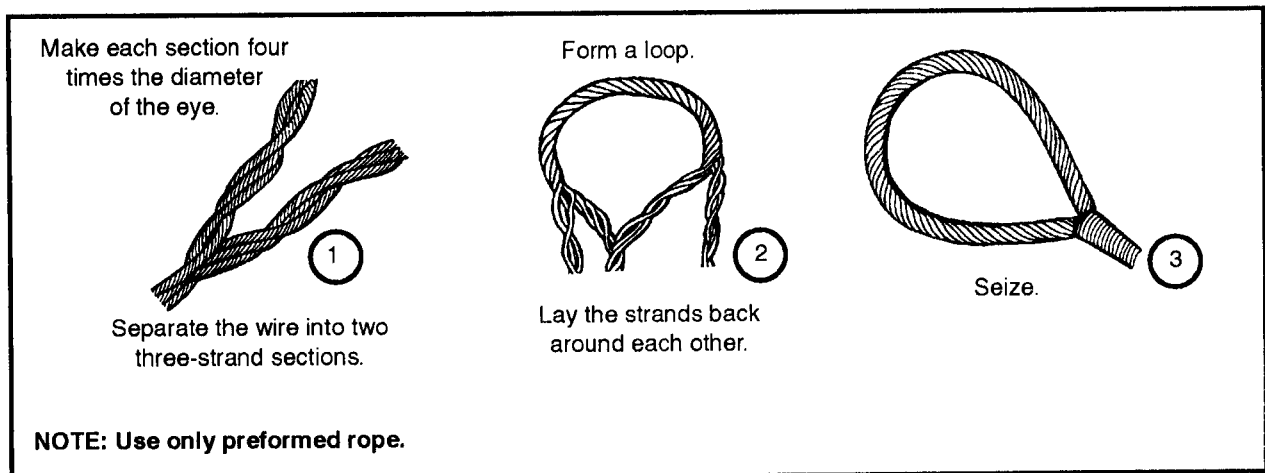
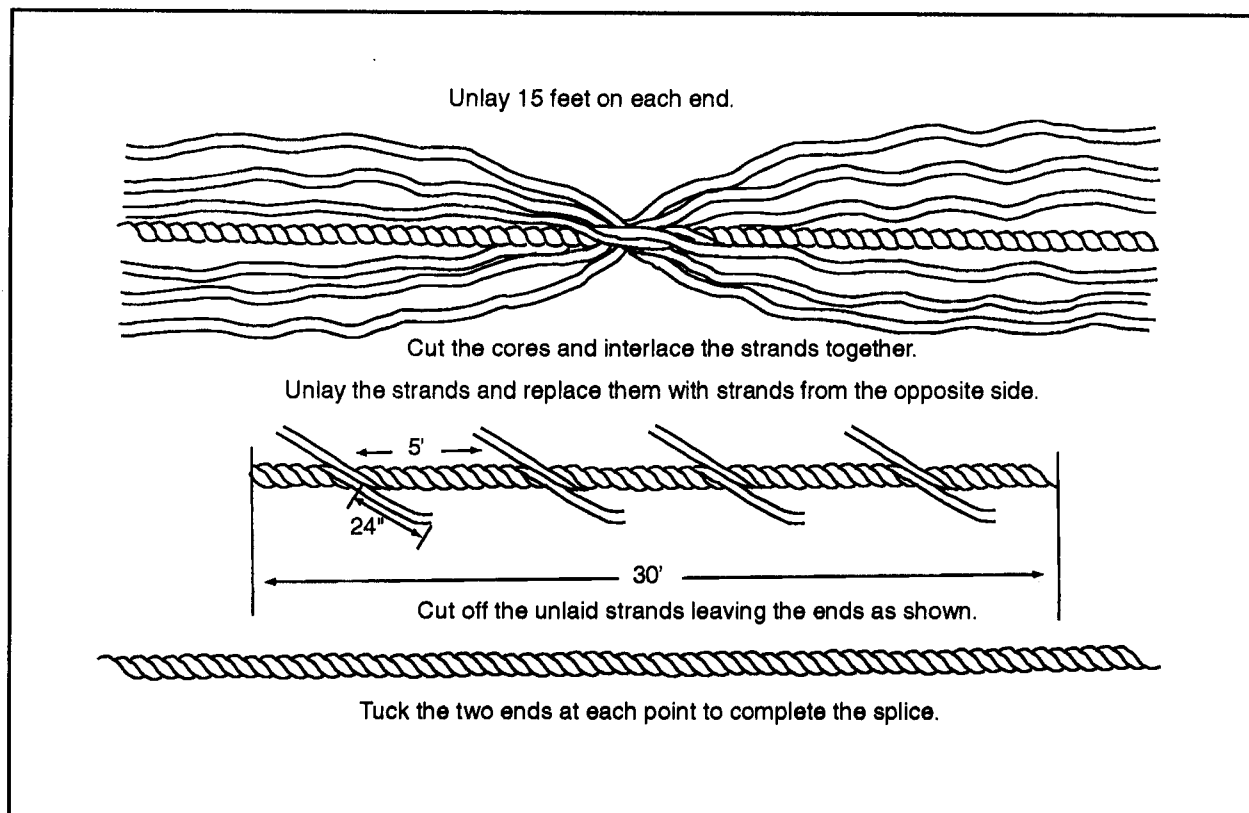

Figure 2-47. Hasty eye splice for wire rope



**Figure 2-48. Long splice for wire rope**

inch regular-lay, round-strand, hemp-center wire rope. Other strand combinations differ only when there is an uneven number of strands. In splicing ropes having an odd number of strands, make the odd tuck at the center of the splice.

#### **Round-Strand, Lang-Lay Rope**

In splicing a round-strand, Lang-lay rope, it is advisable to make a slightly longer splice than for the same size rope of regular lay

because of the tendency of the rope to untwist. Up to the point of tucking the ends, follow the procedure for regular lay. Then, instead of laying the strands side by side where they pass each other, cross them over to increase the holding power of the splice. At the point where they cross, untwist the strands for a length of about 3 inches so they cross over each other without materially increasing the diameter of the rope. Then finish the tucks in the usual manner.

### **Section III. Attachments**

Most of the attachments used with wire rope are designed to provide an eye on the end of the rope by which maximum strength can be obtained when the rope is connected with another rope, hook, or ring. *Figure 2-49* shows

a number of attachments used with the eye splice. Any two of the ends can be joined together, either directly or with the aid of a shackle or end fitting. These attachments for wire rope take the place of knots.

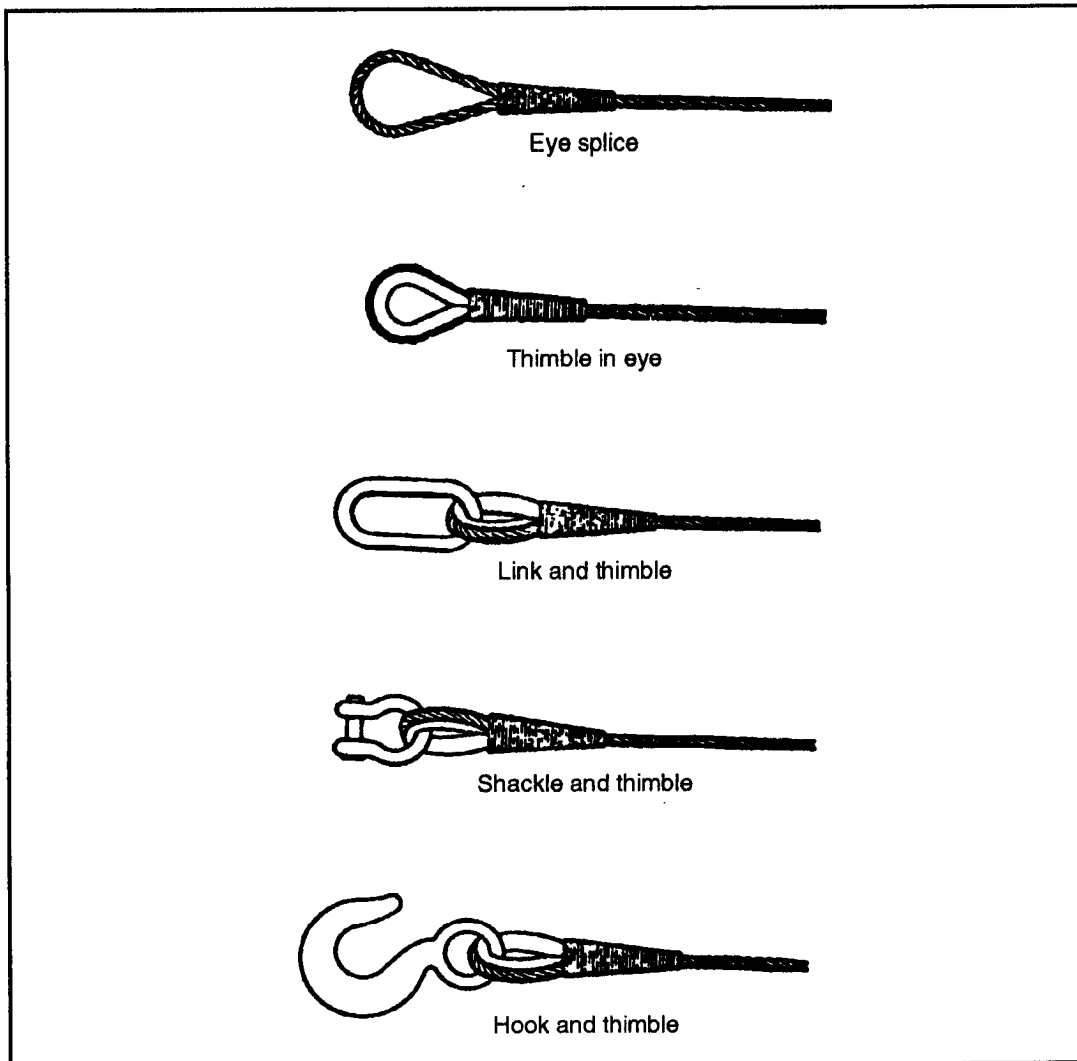

**Figure 2-49. Attachments used with eye splice**

### END FITTINGS

An end fitting may be placed directly on wire rope. Fittings that are easily and quickly changed are clips, clamps, and wedge sockets.

#### CLIPS

Wire-rope clips are reliable and durable (see *Figure 2-50, page 2-36*). Use them, repeatedly, to make eyes in wire rope, either for a simple eye or an eye reinforced with a thimble, or to secure a wire-rope line or anchor-

age to another wire rope. *Table 2-3, page 2-36* shows the number and spacing of clips and the proper torque to apply to the nuts of the clips. After installing all the clips, tighten the clip farthest from the eye (thimble) with a torque wrench. Next, place the rope under tension and tighten the clip next to the clip you tightened first. Tighten the remaining clips in order, moving toward the loop (thimble). After placing the rope in service, tighten the clips again immediately

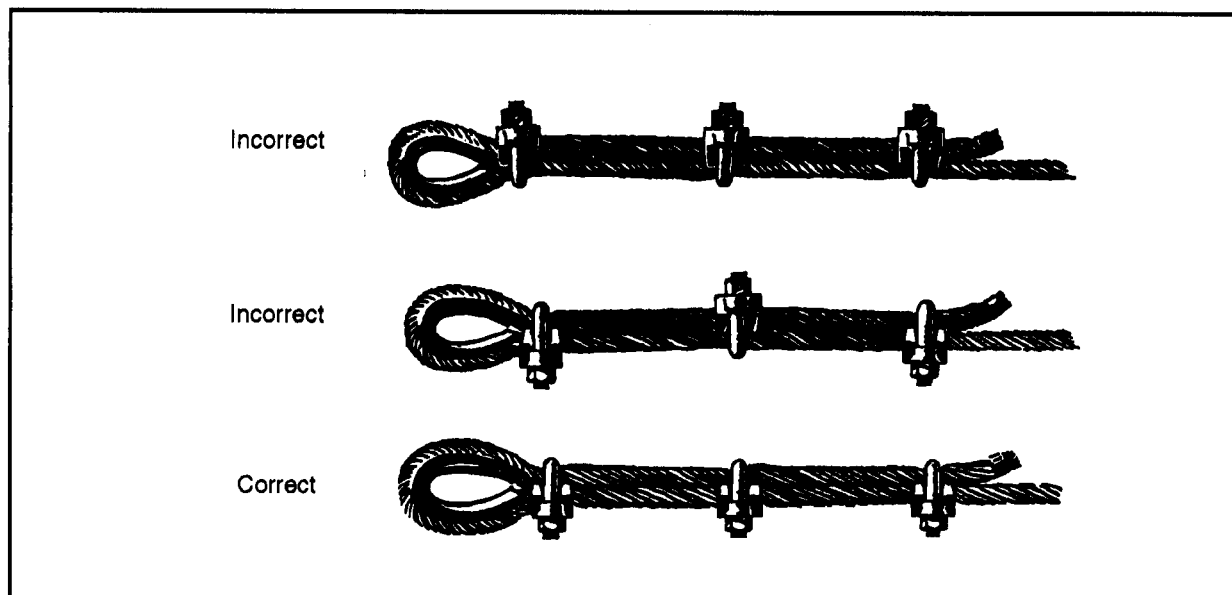

Figure 2-50. Wire-rope clips

Table 2-3. Assembling wire-rope eye-loop connections

Wire-Rope Diameter		Nominal Size of Clips	Number of Clips	Spacing of Clips		Torque to be Applied to Nuts of Clips	
(Inches)	(mm)			(Inches)	(Inches)	(mm)	(ft-lb)
5/16	(7.95)	3/8	3	2	(50)	25	(3.5)
3/8	(9.52)	3/8	3	2 1/4	(57)	25	(3.5)
7/16	(11.11)	1/2	4	2 3/4	(70)	40	(5.5)
1/2	(12.70)	1/2	4	3	(76)	40	(5.5)
5/8	(15.85)	5/8	4	3 3/4	(95)	65	(9.0)
3/4	(19.05)	3/4	4	4 1/2	(114)	100	(14.0)
7/8	(22.22)	1	5	5 1/4	(133)	165	(23.0)
1	(25.40)	1	5	6	(152)	165	(23.0)
1 1/4	(31.75)	1 1/4	5	7 1/2	(190)	250	(35.0)
1 3/8	(34.92)	1 1/2	6	8 1/4	(210)	375	(52.0)
1 1/2	(38.10)	1 1/2	6	9	(230)	375	(52.0)
1 3/4	(44.45)	1 3/4	6	10 1/2	(267)	560	(78.0)

**NOTE:** The spacing of clips should be six times the diameter of the wire rope. To assemble an end-to-end connection, the number of clips indicated above should be increased by two, and the proper torque indicated above should be used on all clips. U-bolts are reversed at the center of connection so that the U-bolts are on the dead (reduced load) end of each wire rope.

after applying the working load and at frequent intervals thereafter. Retightening is necessary to compensate for the decrease in rope diameter that occurs when the strands adjust to the lengthwise strain caused by the load. Position the clips so that they are immediately accessible for inspection and maintenance.

### CLAMPS

A wire clamp can be used with or without a thimble to make an eye in wire rope (see *Figure 2-51*). Ordinarily, use a clamp to make an eye without a thimble. It has about 90 percent of the strength of the rope. Tighten the two end collars with wrenches to force the clamp to a good snug fit. This crushes the pieces of rope firmly against each other.

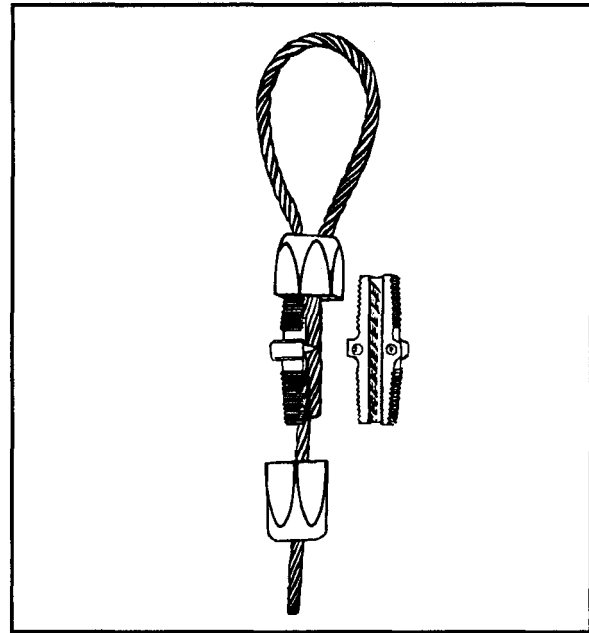

**Figure 2-51. Wire-rope clamps**

### WEDGE SOCKET

Use a wedge-socket end fitting when it is necessary to change the fitting at frequent intervals (see *Figure 2-52, page 2-38*). The efficiency is about two-thirds of the strength of the rope. It is made in two parts. The socket itself has a tapered opening for the wire rope and a small wedge to go into this

tapered socket. The loop of wire rope must be inserted in the wedge socket so that the standing part of the wire rope will form a nearly direct line to the clevis pin of the fitting. A properly installed wedge-socket connection will tighten when a strain is placed on the wire rope.

### BASKET-SOCKET END FITTING

The basket-socket end fittings include closed sockets, open sockets, and bridge sockets (see *Figure 2-53, page 2-38*). This socket is ordinarily attached to the end of the rope with molten zinc or babbitt metal and is a permanent end fitting. If this fitting is properly made up, it is as strong as the rope itself. If molten lead is used instead of zinc, the strength of the connection must be assumed to be reduced to one-fourth the strength of a zinc connection. The socket can be made up by the dry method if facilities are not available to make a poured fitting, but

its strength is sharply reduced and must be considered to be about one-sixth the strength of a zinc connection. In all cases, the wire rope should lead from the socket in line with the axis of the socket.

### POURED METHOD

The poured basket socket is the most satisfactory method in use (see *Figure 2-54, page 2-39*). If the socketing is properly done, a wire rope, when tested to destruction, will break before it will pull out from the socket.

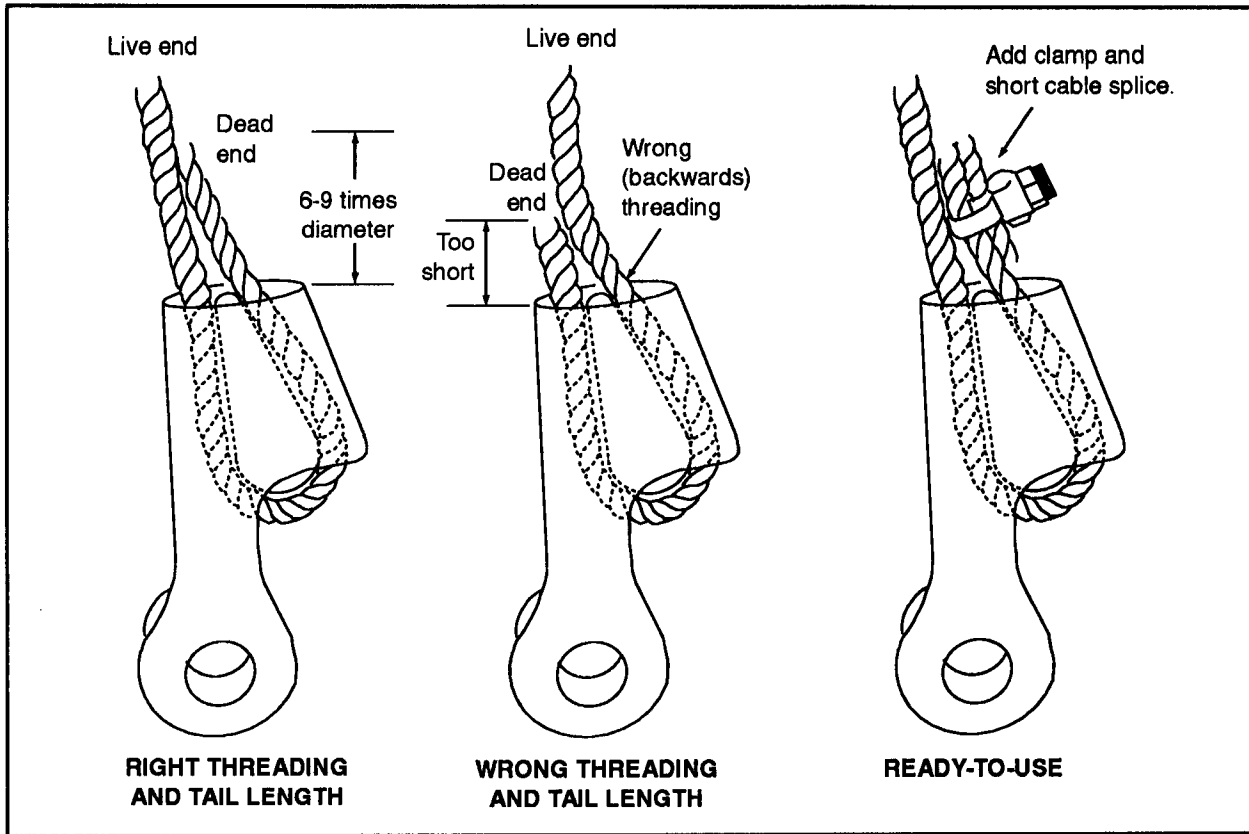

Figure 2-52. Wedge socket

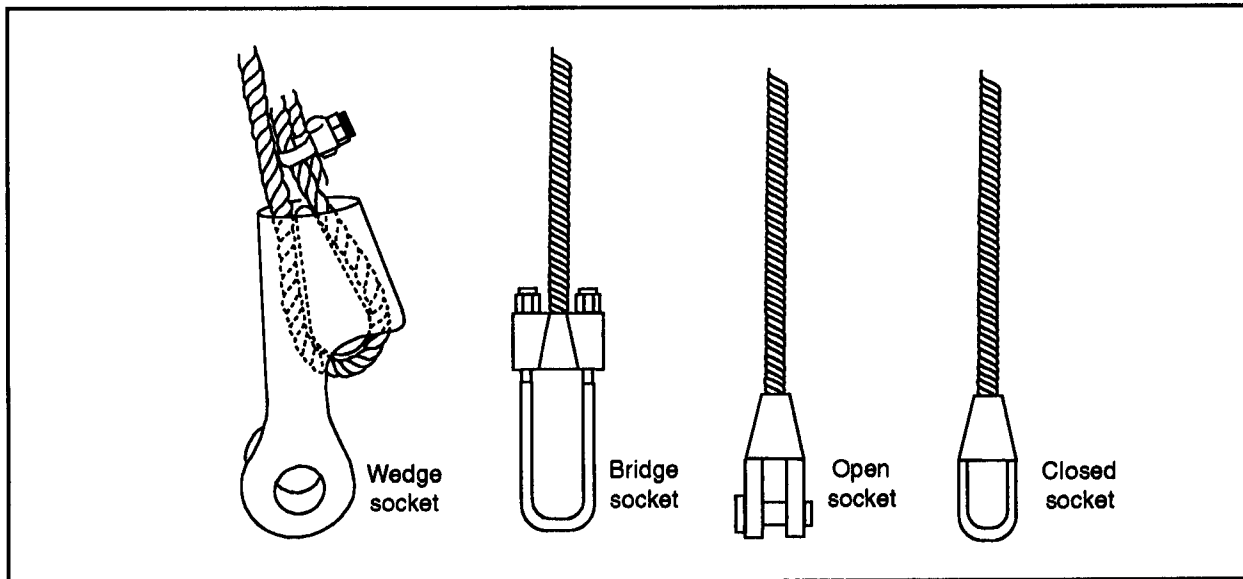

Figure 2-53. Basket-socket end fittings

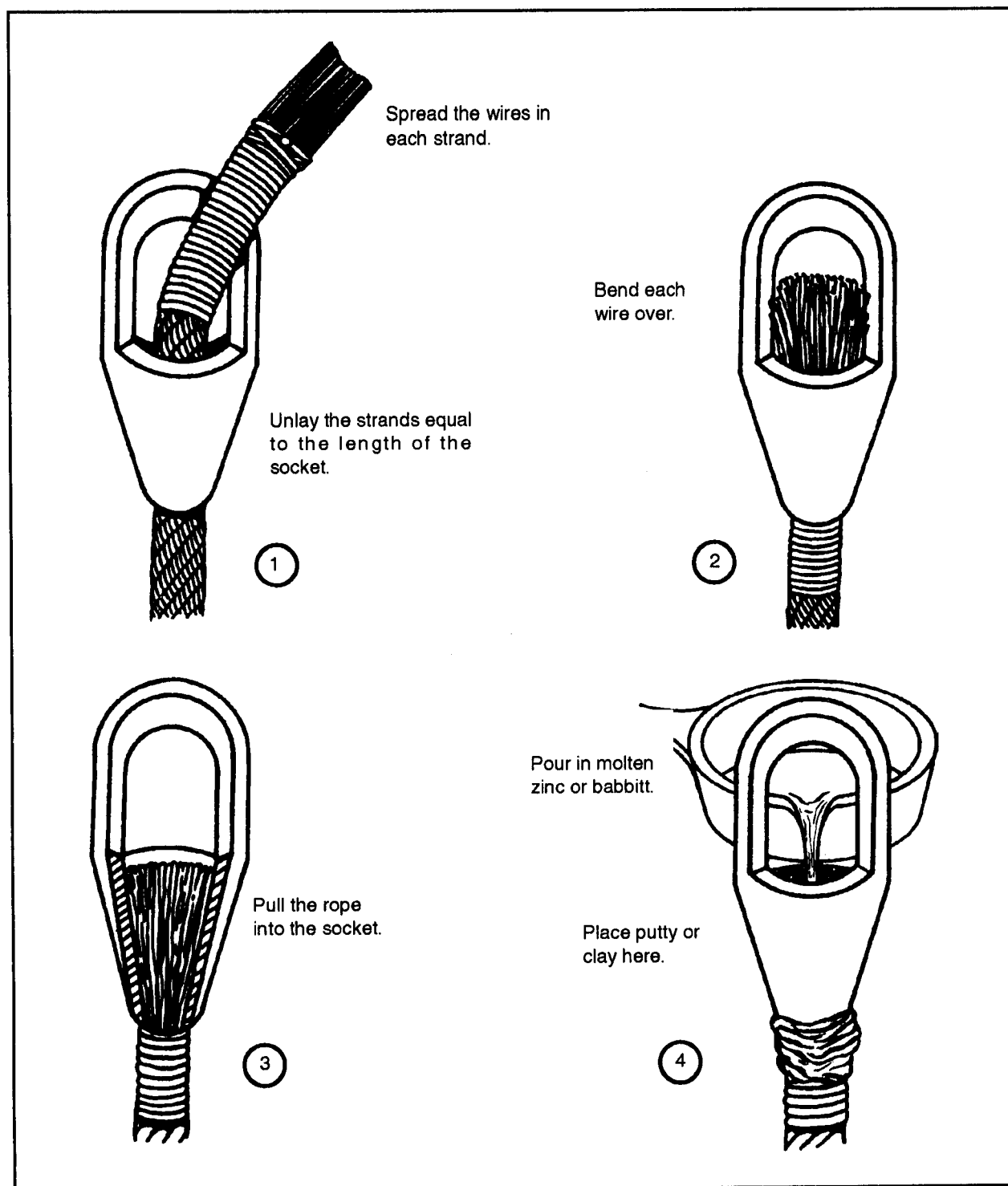

Figure 2-54. Attaching basket sockets by pouring

**DRY METHOD**

The dry method should be used only when facilities are not available for the poured

method (see *Figure 2-55*). The strength of the connection must be assumed to be reduced to about one-sixth of the strength of a poured zinc connection.

**STANCHIONS**

The standard pipe stanchion is made up of a 1-inch diameter pipe (see *Figure 2-56*). Each stanchion is 40 inches long. Two 3/4-inch wire-rope clips are fastened through holes in the pipe with the centers of the clips 36 inches apart. Use this stanchion, without

modifying it, for a suspended walkway that uses two wire ropes on each side. However, for handlines, remove or leave off the lower wire-rope clip. For more information on types and uses of stanchions, see *TM 5-270*.

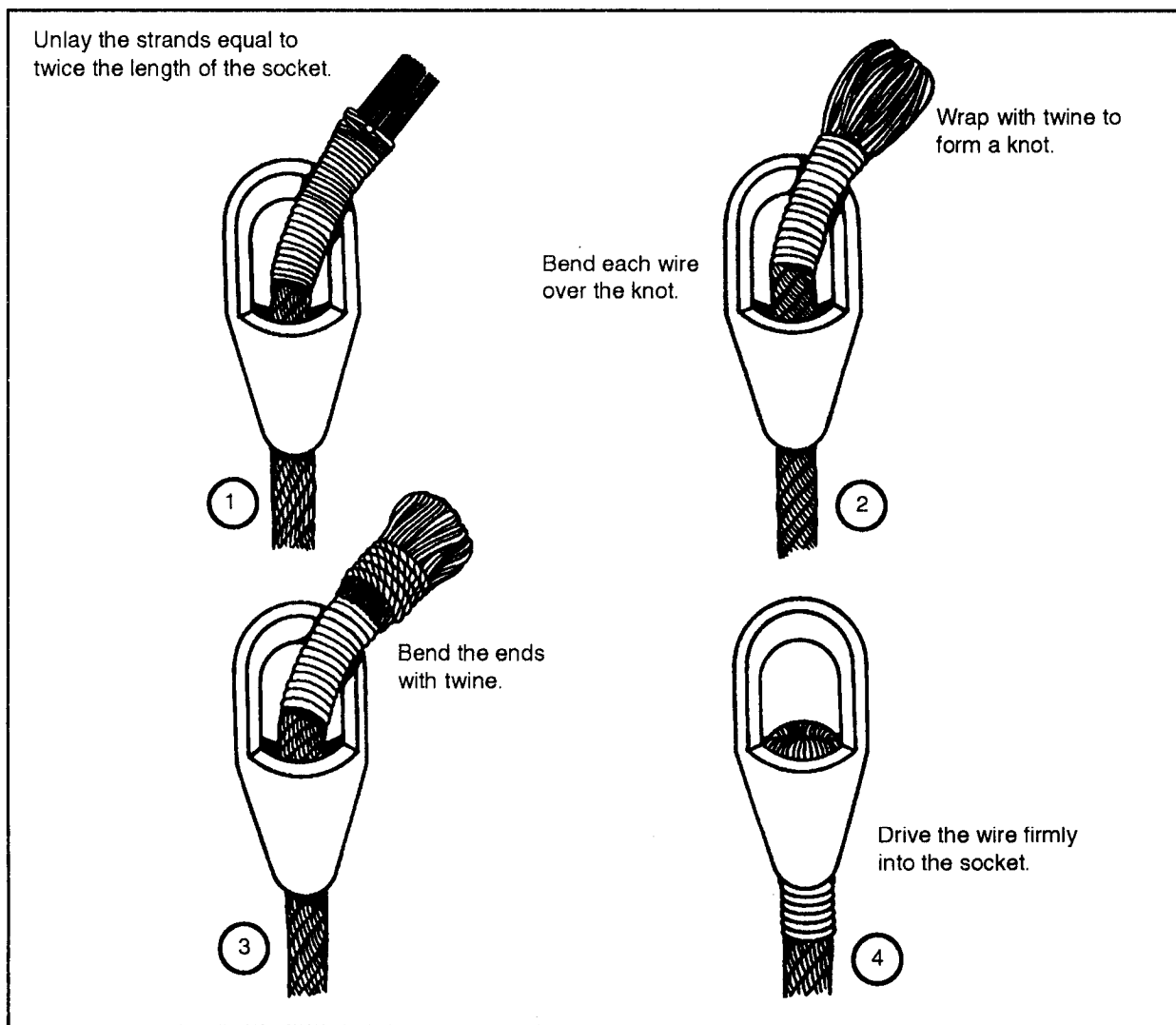

**Figure 2-55. Attaching basket sockets by the dry method**



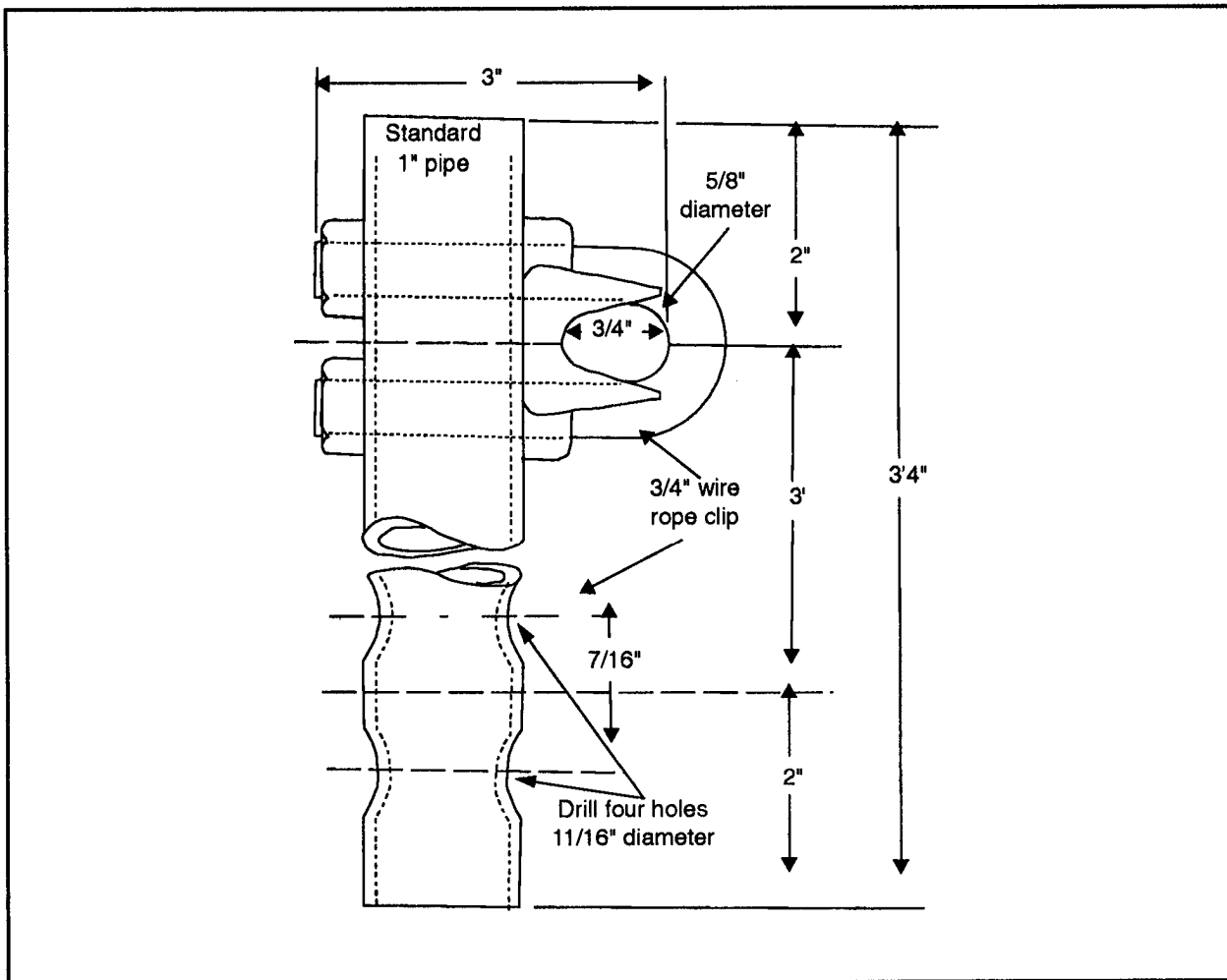

**Figure 2-56. Iron-pipe stanchions**

## Section IV. Rope Ladders

Ropes may be used in the construction of hanging ladders and standoff ladders.

### HANGING LADDERS

Hanging ladders are made of wire or fiber rope anchored at the top and suspended vertically. They are difficult to ascend and descend, particularly for a man carrying a pack or load and should be used only when necessary. The uprights of hanging ladders may be made of wire or fiber rope and anchored at the top and bottom.

### WIRE-ROPE LADDERS

Wire-rope uprights with pipe rungs make the most satisfactory hanging ladders because they are more rigid and do not sag as much as hanging ladders made of other material. Wire-rope uprights with wire-rope rungs are usable.

### Wire-Rope Ladder With Pipe Rungs

Make a wire-rope ladder using either 1-inch or 3/4-inch pipe rungs. The 1-inch pipe rungs are more satisfactory. For such ladders, use the standard pipe stanchion. Space the pipe stanchions 12 inches apart in the ladder and insert the 3/4-inch wire-rope

clips in the stanchion over 3/4-inch wire-rope uprights (see Figure 2-57). If you use 3/8-inch wire-rope uprights, insert 3/8-inch wire-rope clips in the pipe over the wire-rope uprights. When you use 3/4-inch pipe rungs, space the rungs 12 inches apart in the ladder, but do not space the uprights more than 12 inches

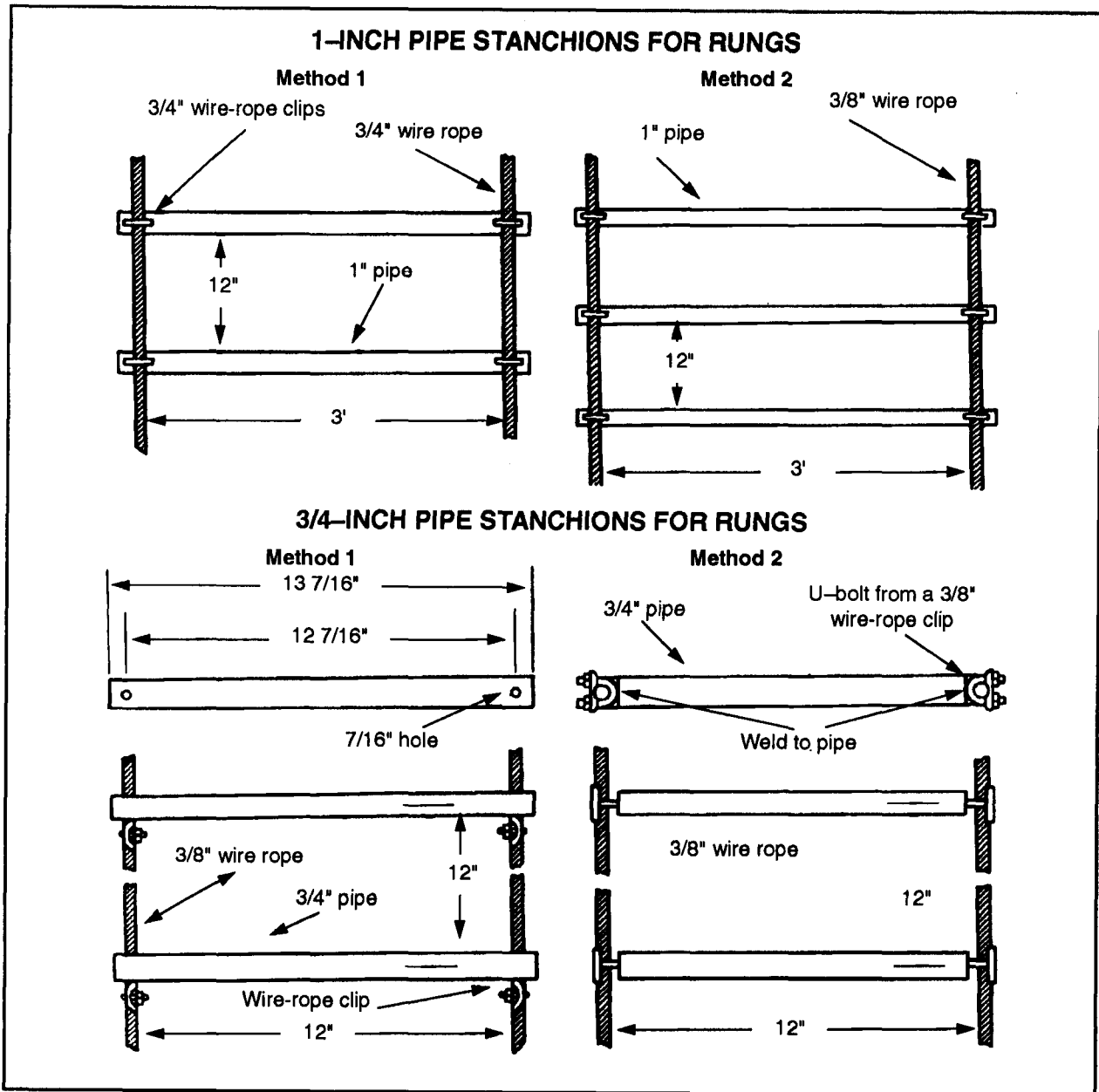

Figure 2-57. Pipe rungs

apart because of using weaker pipe. The rungs may be fastened in place by two different methods. In one method, drill a 7/16-inch diameter hole at each end of each pipe rung and thread 3/8-inch wire-ropes uprights through the holes. To hold each rung in place, fasten a 3/8-inch wire-rope clip about the wire-rope upright at each end of each rung after the rung is in its final position. In the other method, cut the pipe rungs 12 inches long and weld the U-bolt of a 3/8-inch rope clip to each end. Space the rungs 12 inches apart on the 3/8-inch wire-rope uprights. Place the saddle of the wire-rope clips and the nuts on the U-bolts; tighten the nuts to hold the rungs in place.

#### Wire-Rope Ladder With Wire-Rope Rungs

Make a wire-rope ladder with wire-rope rungs by laying the 3/8-inch diameter wire-rope uprights on the ground. Lay out the

first length in a series of U-shaped bends. Lay out the second length in a similar manner with the U-shaped bends in the opposite direction from those in the first series and the horizontal rung portions overlapping (see *Figure 2-58*). Fasten a 3/8-inch wire-rope clip on the overlapping rung portions at each end of each rung to hold them firm.

#### FIBER-ROPE LADDERS

Fiber-rope uprights with wood or fiber-rope rungs are difficult to use because their greater flexibility causes them to twist when they are being used. Place a log at the break of the ladder at the top to hold the uprights and rungs away from a rock face to provide better handholds and footholds. A single rock anchor at the bottom of the ladder is usually sufficient. You can also use a pile of rocks as the bottom anchor for fiber-rope hanging ladders.

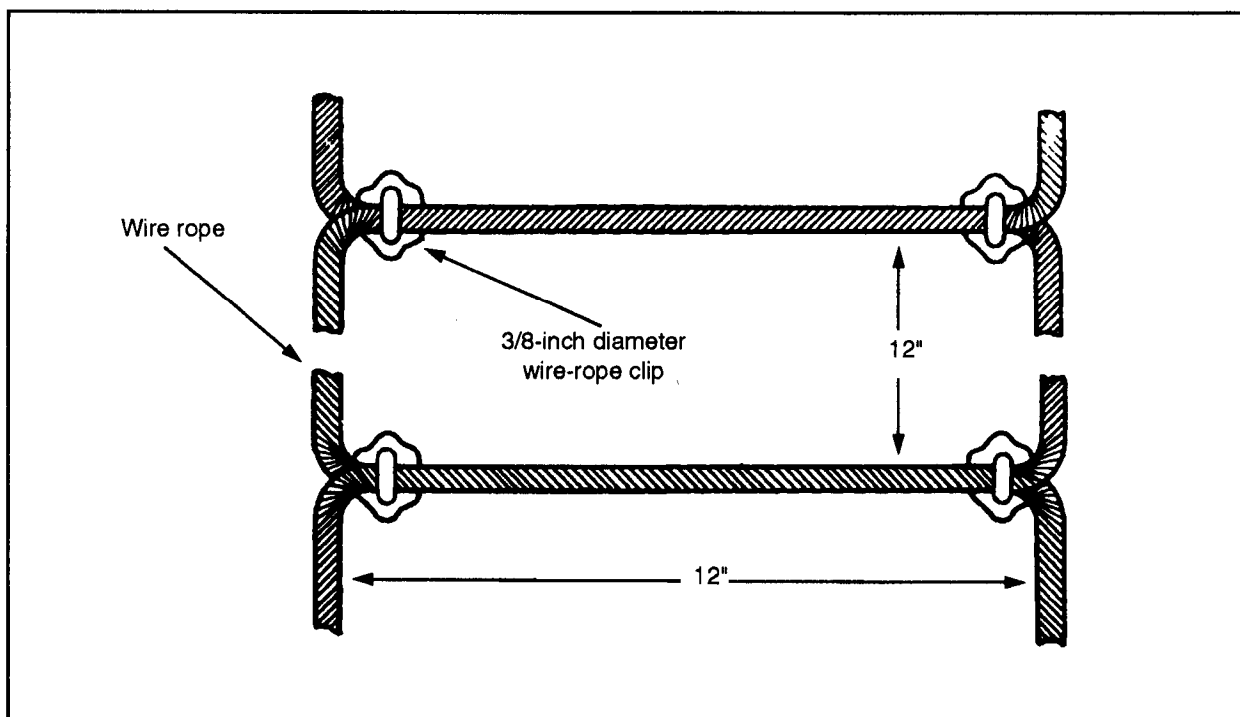

Figure 2-58. Wire-rope rungs

### Fiber-Rope Ladder With Fiber-Rope Rungs

Make fiber-rope ladders with fiber-rope rungs by using two or three uprights. When you use three uprights, make a loop in the center upright at the position of each rung (see Figure 2-59). Space the two outside uprights 20 inches apart. A loop and a single splice hold each end of each rung to the outside upright. A loop in the center of the rung passes through the loop in the center upright. If you use only two uprights, hold the rungs in place by a loop and a rolling hitch or a single splice at each upright. The two uprights must be closer together, with shorter rungs, to stiffen the ladder. Ladders of either type are very flexible and difficult to climb.

### Fiber-Rope Ladder With Wood Rungs

Make fiber-rope ladders with wood rungs by using finished lumber or native material for

rungs (see Figure 2-60). When you use native material, cut the rungs from 2-inch-diameter material about 15 inches long. Notch the ends of each rung and fasten the rung to the fiber-rope upright with a clove hitch. Space the rungs 12 inches apart. Twist a piece of seizing wire about the back of the clove hitch to make it more secure and in a manner that will not snag the clothing of persons climbing the ladder. If you make the rungs of finished lumber, cut them to size and drill a 3/4-inch hole at each end. Oak lumber is best for this purpose. Put a 1/4-inch by 2-inch carriage bolt horizontally through each end near the vertical hole to prevent splitting. Tie an overhand knot in the upright to support the rung. Then thread the upright through the 3/4-inch hole in the rung. Tie a second overhand knot in the upright before you thread it through the next rung. Continue this Procedure until you reach the desired length of the ladder.

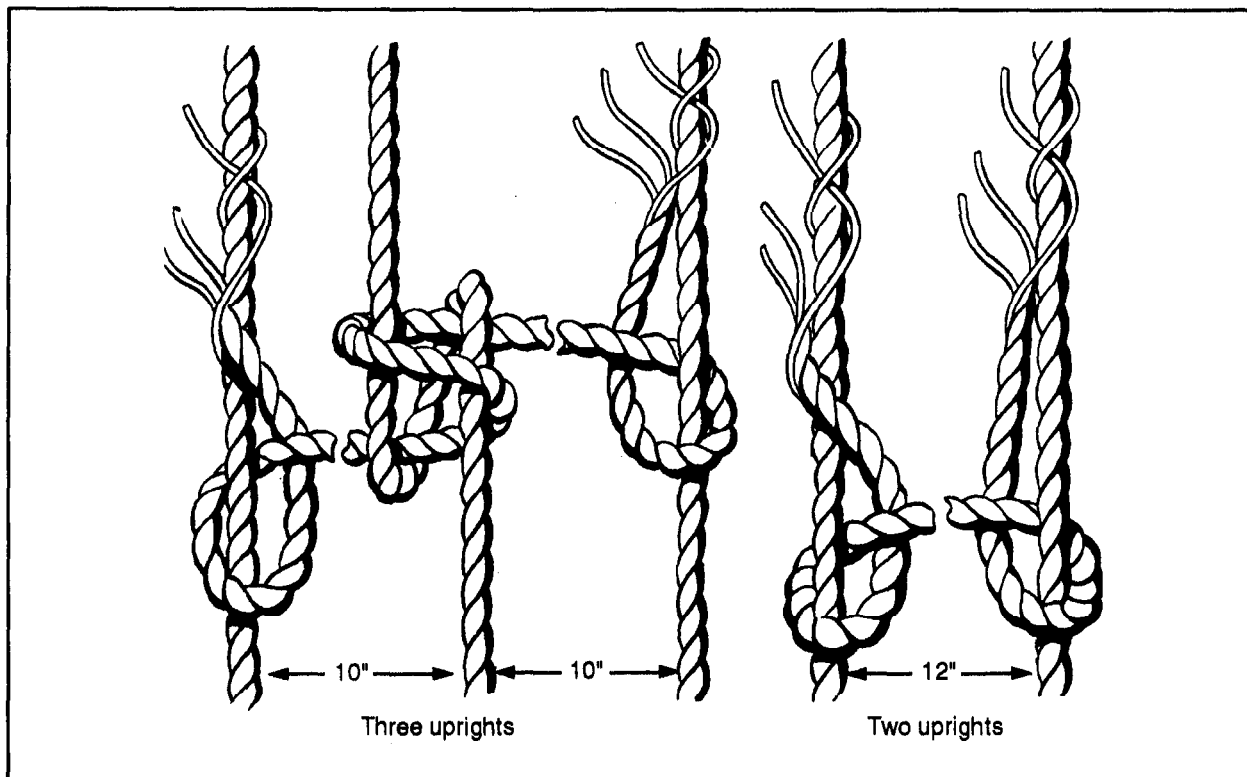

Figure 2-59. Fiber-rope rungs

### STANDOFF LADDERS

Standoff ladders are easier to climb than hanging ladders because they have two wood or metal uprights that hold them rigid, and they are placed at an angle. Both types of ladders can be prefabricated and

transported easily. One or two standoff ladders are adequate for most purposes, but three or four hanging ladders must be provided for the same purpose because they are more difficult to use.

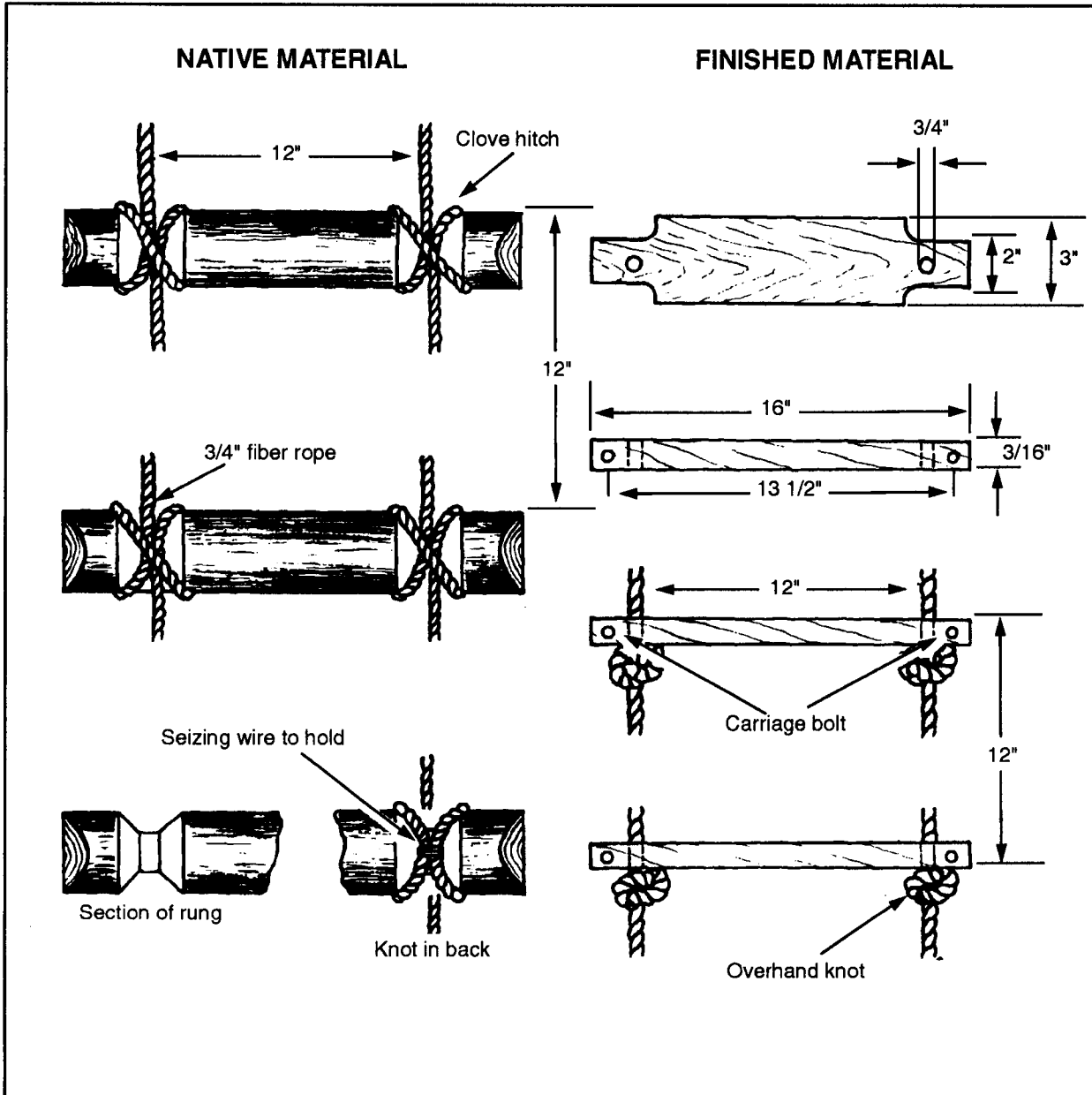

Figure 2-60. Wood rungs