

# **Agrodok 33**

## **Duck keeping in the tropics**

S.J. van der Meulen  
G. den Dikken

© Agromisa Foundation, Wageningen, 2004.

*All rights reserved. No part of this book may be reproduced in any form, by print, photocopy, microfilm or any other means, without written permission from the publisher.*

First edition: 1999

Second (revised) edition: 2004

Authors: S.J. van der Meulen, G. den Dikken

Editor: Arno Overgaag

Illustrator: Barbera Oranje

Translation: Sara van Otterloo-Butler

Printed by: Digigrafi, Wageningen, the Netherlands

ISBN: 90-77073-85-X

NUGI: 835

# Foreword

Ducks are tough animals and good scavengers. They are easier and cheaper to keep than chickens. This makes duck keeping for the production of eggs and meat an attractive enterprise.

Agromisa and CTA have produced this Agrodok in order to support people in improving their daily livelihood. This can be done either through income generation from a small-scale duck keeping enterprise or through improving the daily diet with duck eggs and meat.

We hope that many people will benefit from this Agrodok.

We are grateful to Mr Buisonjé of the Spelderholt Institute in Beekbergen, the Netherlands. Being an expert on poultry and duck keeping he has provided valuable information and practical knowledge. We have appreciated the time and effort he has put into improving the contents of this Agrodok.

Arno Overgaag, editor

Wageningen, 2004

# Contents

<b>1</b>	<b>Introduction</b>	<b>6</b>
1.1	Basic facts about duck keeping	6
1.2	Points to remember	8
1.3	Outline of this book	9
<b>2</b>	<b>Breeds and breeding</b>	<b>11</b>
2.1	Breeds and choice of breed	11
2.2	Breeding	15
2.3	Breeding stock	17
2.4	Maintaining a flock	18
<b>3</b>	<b>Ducklings</b>	<b>20</b>
3.1	Incubating eggs the natural way	20
3.2	Some info on hatching in an incubator	21
3.3	Selection in flock traits	23
3.4	Sexing ducklings	24
3.5	Caring for the ducklings	25
<b>4</b>	<b>Duck keeping systems</b>	<b>29</b>
4.1	Duck keeping systems - extensive or intensive	29
4.2	Combining duck keeping with rice cultivation	32
4.3	Combining ducks with fish culture	32
<b>5</b>	<b>Housing</b>	<b>38</b>
5.1	Night shelter	38
5.2	Separate laying area	39
5.3	Floor	40
5.4	Feeding troughs	40
5.5	Drinking water systems	42
5.6	The importance of water	43
5.7	Daily care of ducks	44
<b>6</b>	<b>Health care</b>	<b>45</b>

6.1	Preventive health care	45
6.2	Preventive health care	45
6.3	Diseases	47
<b>7</b>	<b>Feeding</b>	<b>52</b>
7.1	Drinking water	52
7.2	Quantities of food	53
7.3	Nutrients in feed	54
7.4	Feed composition and requirements	56
7.5	Food poisoning	62
<b>8</b>	<b>Products</b>	<b>63</b>
8.1	Production figures and daily care	63
8.2	Care of eggs	64
8.3	Slaughtering ducks	66
8.4	Manure	67
<b>9</b>	<b>Keeping farm records</b>	<b>68</b>
9.1	Keeping records	68
9.2	Calculating the cost price	69
9.3	An example of calculating the cost price	71
9.4	Analysing your business over more seasons	73
	<b>Further reading</b>	<b>76</b>
	<b>About WPSA</b>	<b>78</b>
	<b>Glossary</b>	<b>80</b>

# 1 Introduction

This Agrodok covers a number of subjects which arise if you yourself, or people you work with, are considering keeping ducks. The aim is to give practical advice on small-scale duck keeping for those who work directly with small-scale farmers. A theoretical background is given in order that users of this book are able to develop the most suitable practices for their particular situation.

## 1.1 Basic facts about duck keeping

About 700 million ducks are kept around the world. The majority of these, more than 500 million, are found in Asia. Despite this uneven distribution, it is certainly also possible to raise ducks in other parts of the world, including Africa and Latin America.

Ducks can be reared for eggs and meat, for own use or for sale. Other products from ducks, which can also be sold, include down, feathers and fattened livers (foie gras).

There are many similarities between chicken and duck rearing. The most obvious similarities are found in the type of products for which these forms of poultry are kept. Ducks, like chickens, are good producers of eggs and meat. Breeding is largely similar for both. Ducks have approximately the same housing requirements as chickens, especially when they only require night shelter. If the ducks are outside during the day, just like chickens they will be capable of searching for a large part of their food.

### **Advantages of ducks compared with chickens:**

- Ducks are tougher than chickens; they require less attention than chickens and are less likely to be sick than chickens.
- Ducks are larger than chickens, so if they are reared for meat there will be more to sell. Duck eggs are also larger than chicken eggs.
- Ducks do not necessarily need supplementary grain and maize. Chickens normally do need supplementary high quality feed. Ducks

eat more vegetable material and insects than chickens. Ducks also eat snails.

### **Disadvantages of ducks compared with chickens:**

- Both duck meat and eggs taste different from those of chicken. Not everyone likes the taste of duck. If the taste is disliked by a lot of people it will be difficult to sell duck products. Not only does duck meat taste different it also looks different from chicken meat. Chicken meat is white whereas duck meat is red and dark. Lastly, duck meat is also fattier than chicken meat. Although this is listed here as a disadvantage that is not necessarily the case. In many areas fatty meat is considered a delicacy.

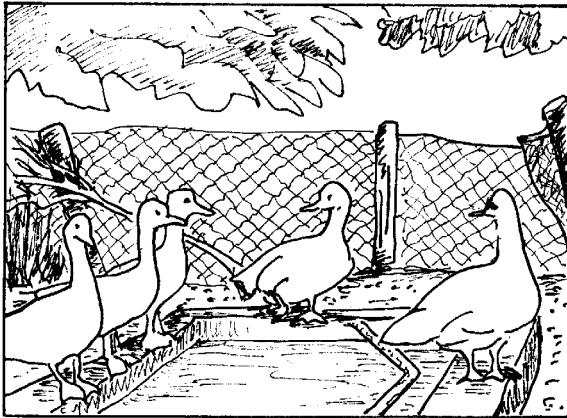

*Figure 1: Ducks near a pond of water*

- Ducks are water birds and need water to be able to breed and grow well. A pool or pond of water can take up a lot of room. A trough of water can also be provided so that ducks can bathe. If it is not possible to keep ducks near water the whole day it is sufficient to place a tub of water out for them in the mornings and evenings so that they can wash. Pools, ponds, troughs or tubs of water all need to be kept clean and hygienic. Different sorts of ducks differ in their water requirements. Muscovy ducks (sometimes called Barbary duck) have less need to cool themselves and so have less need for a con-

stant supply of bathing water. Peking ducks come originally from colder climates and live near to water. These ducks need water to keep their body temperature at the right level.

## 1.2 Points to remember

There are many ways of raising ducks. The simplest method requires little capital input, where ducks are raised in the farmyard as part of a mixed farm. This is the so-called free range system. At the other extreme, large-scale, capital-intensive duck rearing can take place on a farm on which only ducks are raised inside a covered shelter or confined indoor system. Between these two extremes there are many different forms in which the ducks are offered an indoor shelter and a run in which they can go outside.

In order to decide how to raise ducks, a farmer or extension worker needs to consider a number of points:

- Are the ducks intended for your own use or do you also want to sell a duck product?

If you are considering keeping ducks in order to sell their products it is important to know whether there is a market for the eggs or meat.

- Will duck rearing fit in with the rest of your activities? Do you have room for ducks?

Not only do you need room for shelter and a water supply for the ducks, but their daily care also takes time and may get in the way of other activities.

- Where will you get your ducklings in order to maintain a stock? Will you breed yourself or will you buy ducklings when you need them?

If you plan on buying them, can you be sure that there will be a regular supply in the future?

If a trader or breeder cannot guarantee that ducklings will be available in the future, you have to consider breeding ducks yourself. Can you provide the time and care to do so?



- What will you feed the ducks? Where can you obtain feed? Do you have sufficient food available on your own farm or will you have to buy some types of feed?

Ducks are capable of scavenging for a large part of the food themselves, but it is often necessary to give them extra in the dry season. If ducks are free range they are more likely to suffer from a shortage of vitamins or minerals.

### 1.3 Outline of this book

*Chapter 2* describes different types of ducks with their different characteristics, which make them suitable for different purposes. Once you have ducks, maintaining the flock is important. This can be done through hatching out your own eggs or buying ducklings regularly and raise them. Important factors and ways to raise ducklings are treated in *Chapter 3*.

*Chapter 4* describes two systems of duck keeping: free range, and confined. Two integrated systems are highlighted: duck keeping in combination with rice cultivation and with fish farming.

*Chapter 5* is about housing for ducks. Different types of shelter are described, the dimensions required, as well as feeding and drinking trays.

*Chapter 6* describes some basic aspects of preventive health care, hygiene of the housing and the surroundings being the most important factor. Ducks are basically quite tough animals, but for the occasional time when they do become ill, the most common diseases are described.

*Chapter 7* covers feed. Although ducks are good scavengers, you can often obtain better production levels by supplementing their feed. The different requirements of egg and meat-producing ducks are outlined in this chapter.

Ducks are most often raised for their eggs and/or meat. *Chapter 8* provides an indication of the levels of production you can expect to achieve. Care of the products is also discussed in this chapter.

*Chapter 9* provides a reminder that if you keep a record of what happens on your farm it is easy to have an overview and to improve management.

Of course all farms differ from each other. For this reason you should consider this Agrodok as a handbook in which several possibilities are presented. You have to decide yourself what is possible and suitable for your own situation and which improvements you can make.

## 2 Breeds and breeding

### 2.1 Breeds and choice of breed

When starting with duck rearing you need to acquire ducks. This is when you will choose a breed:

If there is a choice of breeds available then you need to consider what your production objectives are: eggs, meat or both. If you decide to rear ducks for egg production then you need to have good laying ducks. These are usually smaller and lighter than birds reared solely for meat production (for fattening). They make up for their lack of growth and weight by being better layers: on average laying ducks lay more eggs than ducks for fattening. Ducks for meat (broilers) are generally larger and heavier, and the number of eggs they lay is of less importance. If you consider an intensive production system with rapid growth, meat ducks are slaughtered before they have even reached the age at which they can produce eggs.

In many forms of farming, especially small-scale farming, *egg production as well as meat production* will be important. A duck that is a good layer but also can produce a nice amount of meat is best for this kind of farming. As mentioned above, you may not have a choice of breed. In this case you simply use the duck breed which is easiest to come by. The advantage to using locally available ducks is that you can always obtain them if you need to replace or increase numbers.

Duck keeping is more common in Asia than in Africa or Latin America, which means that there are more different breeds available there. Each breed of duck is well adapted to the conditions in the area from which it originates. Below a number of breeds are described.

## The Muscovy or Barbary duck

This duck comes originally from Central America. The Muscovy duck is good for meat production. It is easy to recognise by the red, fleshy protuberances around the beak and eyes. It is important to know that the Muscovy duck is originally a tree dweller and therefore can fly. In order to prevent these ducks from flying away their wings need to be clipped. Use a pair of scissors to cut most of the large feathers of one wing.

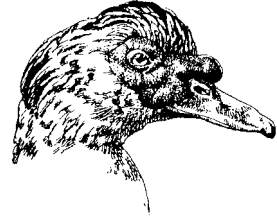

*Figure 2: Muscovy duck*

A Muscovy duck used for fattening can reach a weight of 3 to 5 kg. The Muscovy duck does not grow very quickly and its final weight depends on the way it is kept and the feed it gets. The meat of the duck is fairly lean. In areas where fattier meat is preferred then it is probably better to choose a different breed. The duck starts laying eggs at about 7 months. There are two clear laying periods with a break of 12 weeks; the first lasts 30 weeks and the second 22 weeks. The duck hatch and raise ducklings reliably. Which makes them valuable for the small-scale farmers.

## The common duck: group of various breeds

This group includes various breeds, which originate from Asia and have been imported into Africa. The most important include:

- Khaki Campbell duck: a khaki (beige) coloured duck, originated from England from a cross between the Indian ‘Runner’ and the Rouen duck. The Khaki Campbell is well suited to a tropical climate. Under good conditions this breed is capable of laying up to 250-300 eggs per year. In Asia the breed is used for improving the productivity of local breeds.

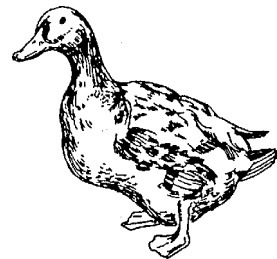
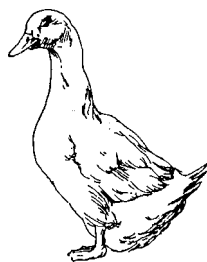

*Figure 3: Khaki Campbell duck*

- *Rouen duck*: originated from France; a reasonably heavy breed; good layers. The drake (male) is light grey with a green neck and the female is light brown like mallards (wild ducks).

### **Peking ducks**

A completely white duck that originally comes from cool climates in China. This breed is a meat and egg producer like the Muscovy duck. The Peking duck grows quicker than the Muscovy duck. One of the characteristics, which indicate that the Peking duck is good for meat production, is that it can reach a weight of 3 kg by the age of 7 - 9 weeks. Drakes usually attain a maximum weight of 3.5 - 4 kg and females 3 - 3.5 kg. Peking ducks lay eggs from an age of 5-6 months and can lay more than 200 eggs a year. Peking duck meat is quite fatty, unlike that of the Muscovy duck. It is a quiet breed that tends to walk rather than fly. Incidence of brooding behaviour is rare. Peking duck

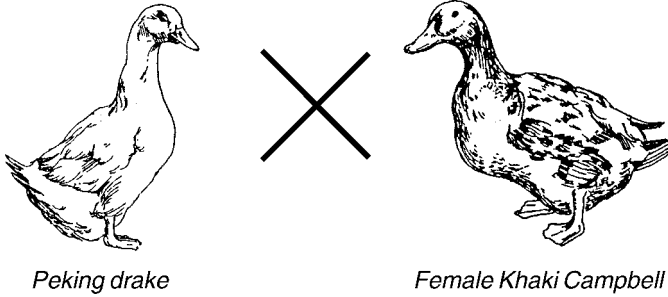

*Figure 4: Peking duck*

### **Cross-breeds**

Breeds are regularly crossed in an attempt to obtain a combination of good characteristics of two different breeds. Sometimes the results of cross-breeding are used for further breeding themselves, sometimes new crosses are made each time. There are a number of standard cross-breeds:

- A Peking drake is crossed with a female Khaki Campbell. This is a cross between a good meat producer and a good layer. In this way the cross-breed should combine good meat production with good egg laying. First and second generations (referred to as  $F_1$  and  $F_2$ ) are used quite commonly. Further generations are not generally used, as the improvements obtained by crossing usually start to decline by that stage.



*Figure 5: A common cross*

- The mule duck is a cross between a Muscovy drake and a female common duck. As these are two different species the resulting mule duck is sterile and does not lay fertile eggs. The mule duck is a quick fatter and is used especially for this purpose.

### **Other breeds**

In addition to the breeds described above there are many more breeds and crosses. These include:

- Indian runner duck (from India)
- Nageswari (from India)
- Chinese duck (from Indochina)
- Java duck (from Malaysia and Indonesia)
- Brown and White Tsaiya (from Taiwan)

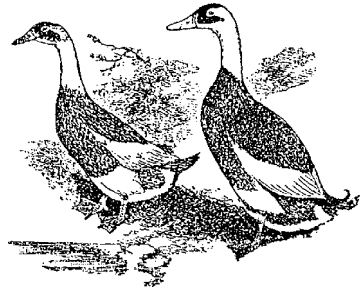

*Figure 6: Indian runner ducks*

Most duck breeds come from Asia and are kept for egg laying. These breeds are therefore generally not very large, the adult weight being between 2 and 3 kg.

## **Variety in production**

All breeds have different characteristics in terms of egg production, growth rates and survival rates. Where production figures are available these should be used only as guidelines to help you make decisions. The figures will depend very much on the local conditions where they were collected. More detail on production figures can be found in Chapter 8.

Peking ducks tolerate a cool climate. Muscovy ducks are from a warmer climate, require a temperature above 20°C.

If there are farmers in your area (or in other areas with similar conditions) who already keep ducks, it is worthwhile going to look at how they are rearing the ducks and for what products. This will give a better idea of the results you can expect.

## **2.2 Breeding**

Once you have obtained a number of ducks of the selected breed, you need to consider how you will maintain productive ducks over a longer period. Choose one of the following three options.

- If you keep ducks purely to sell their eggs and you buy ducklings whenever you need them, you will only need female ducks.
- If you intend to breed your own ducks then you need drakes as well to ensure that you have some fertile eggs.
- If you are keeping ducks for meat you have to make sure that you keep enough adult ducks for laying eggs so that you have a supply of ducklings.

**Advantages** of breeding ducks yourself are:

- You are not dependent on other suppliers of young ducks.
- You don't have to spend money on buying ducklings.
- You don't import diseases with the ducklings.

**Disadvantages are:**

- You have to incubate eggs, which cannot be sold. You have to spend time and money on incubating eggs.
- The effort of incubating eggs may be wasted if they don't hatch.
- Although you want only eggs, you will have to keep and feed unproductive drakes (males) as well, in order to obtain fertile eggs.

For small-scale farmers it is more profitable to breed ducks themselves especially if the numbers of ducklings they need are small.

**Two ways of breeding:****➤ *Free breeding***

If you keep the female ducks and drakes together then getting fertile eggs or ducklings will usually be no problem. The drakes are free to mate with any duck they want. However, in this way, you will have no idea of which drake has fertilised which ducks.

**➤ *Directed breeding***

You can also direct the process yourself so that you combine the ducks with the most desirable characteristics. In this way you keep ducks especially for producing ducklings, these are known as breeding stock (see next section).

The extent to which you can determine which drake pairs with which duck depends on how you keep your ducks. If the ducks are only kept inside at night but are allowed to wander around freely at daytime in search of food then it is very difficult to even know which duck has paired with which drake. If you keep ducks in this way it is not worth spending much time trying to determine partner choice. The best thing to do is to put a number of good drakes into the flock and let them go their own way. This is the most simple and natural way of ensuring that you will have ducklings.

If you have possibilities and time then you could consider making separate sections in shelters, so that you can put one drake together with a number of ducks (4 - 8) so that they can mate.



## 2.3 Breeding stock

As stated before, breeding stock are ducks with desirable characteristics which you like to see in the ducklings. For example you may choose to combine a drake that grows well and has a good amount of meat, with a duck that is a good layer. Bear in mind, however, that not all characteristics are passed on from the parent duck to its offspring, but generally speaking the chance of breeding good ducklings is greater if good parents are used. Characteristics that you are looking at can be production characteristics or external characteristics.

### ➤ *Production characteristics*

Most of the characteristics which are related to production are about quantity: the number of eggs, the weight of meat, etc. An important feature of these characteristics is that the environment influences them. These you can influence yourself as duck keeper. A duck which is bred for high meat production will only be able to achieve high production levels if it gets enough food.

If you want to increase your production levels you should first look carefully at your food supply, sickness levels and housing. Once you have made sure that you have the best food available, and that your ducks are healthy and have good housing, only then you can start breeding for a better production.

### ➤ *External characteristics*

Above we have discussed selection for production characteristics. External characteristics may also be important, such as foot quality. If a number of ducks in a flock have bad feet it is better not to use them for breeding as they can pass this characteristic on to their young. External characteristics are not influenced by the amount of feed or housing. A duck will either have straight feet or not, or brown colour or not, so it is easy to use this kind of criterion for selection.

## **The management of female ducks and drakes**

To ensure that you have enough fertile eggs, a good ratio is one drake to six female ducks in meat-type ducks. In egg-type ducks you can put

eight female ducks to one drake. If you have less female ducks per drake the chance of fertile eggs increases, but less than four female ducks per drake is not recommended. A relatively large number of drakes in a flock makes the whole flock restless. It also means that you have more drakes to feed. Sell them as soon as they are grown up.

In Muscovy ducks introduce drakes into the flock about a month before you require fertile eggs. This ensures that enough pairing has taken place for the ducks to lay fertile eggs. In common ducks like Peking ducks you have to make sure that males and female keep their sexual behaviour. Therefore, they have to be kept together from 3 weeks of age.

Give ducks access to water. Ducks are water birds and they can keep themselves clean (and therefore more healthy) if there is water in which they can bathe. Brooding ducks that can keep themselves clean are better able to maintain the right level of humidity for the eggs. It is often thought that mating can only take place on the water. But access to water does not improve fertility.

Bathing is not necessary for Muscovy ducks as these are originally tree-dwellers. Remember that sitting water can also be a source of disease.

## **2.4 Maintaining a flock**

There are two ways of obtaining and keeping a flock of ducks with the best possible features. Both methods should be practised at the same time:

- 1 Selecting ducks and drakes for breeding (see above)
- 2 Culling (removing) unhealthy ducks or low producers

Culling means: removing from the flock. Dispose first of ducks that are so sick that you can no longer treat them or that are not worth treating (see chapter 6 for more information on health care). It is also worth getting rid of ducks which have already gone through several laying cycles and are not so productive any more. They make way for younger ducks.

Once this has been done, further culling will be of ducks that possess undesirable characteristics: those that do not produce enough. Do not breed with ducks that are bad layers or do not fatten well, as there is a chance that they will pass these characteristics on to their young. The decision when to cull, especially older ducks, will depend largely upon when new ducklings are available.

There are three different ways to practise culling. These are described below.

### **Culling systems**

➤ *Continuous system:*

In this system a few new ducklings are added regularly to the flock. The ducks are not separated into age groups as there are no clear age groups. Besides watching for sick ducks you also have to keep an eye on the older ducks and remove them once they become unproductive.

➤ *All-in-all-out:*

The whole flock is renewed at regular intervals. In this system you do not have to check which ducks have become too old as all ducks are the same age. You should still check for sick ducks and remove them immediately. If you use this system you will often have different groups of ducks at different stages of production. This way you avoid being a situation where you have no ducks (and therefore no production) at all. Intensive production systems use age groups.

How many ducks you can cull will depend on the number of ducklings you can raise with each laying cycle. You have to be careful that the number of the flock does not decrease too much if you want to maintain your production at a constant level; if you remove more breeding animals than you can replace your production will go down.

## 3 Ducklings

Since the production period for meat is short and the growth is fast, you need a secure supply of ducklings. You may buy day-old-ducklings on the market, that are hatched in an incubator. Or you may have ducks that become broody easily and hatch the eggs of your own flock.

If the duck is going to incubate the eggs herself, the nest needs to be ready in time to give the duck a chance to get comfortably installed on it. She will take care of the eggs and you don't have to worry much because the duck will make sure that the circumstances are right for the eggs.

If you have to raise the ducklings from an incubator in a brooder, you need to have it ready in time. You then need to keep a close watch on the temperature. It requires technical equipment, which has to be used accurately. Unforeseen occurrences such as an electricity failure or running out of fuel can lead to disaster. For this reason you need to consider carefully the advantages and disadvantages of natural versus artificial hatching; what are the costs (not only in money, but also time) and what are the expected returns?

### 3.1 Incubating eggs the natural way

Hatching eggs the natural way means that they are incubated by a duck. The big advantage to this method is that the eggs require little time and attention. The most important requirement is that the duck that is going to incubate the eggs is sufficiently broody. Being broody means having the urge to stay sitting on the eggs until they hatch. You can tell whether a duck is broody or not by how long she remains sitting on the eggs. The eggs cannot be left alone for more than 15 minutes as they must not cool down too much. The ducklings then cannot develop.

Most ducks will sit on their own eggs. However, it is also possible to let one duck from the flock sit on eggs which have been laid by other ducks. In this way about 12 eggs, which were laid at the same time, can be incubated by one duck.

The Muscovy duck has good broodiness and maternal instincts. It can therefore be used for incubating the eggs from other types of duck. The Muscovy duck is also larger than many other types, so it can incubate more eggs at once. You will have to see how many eggs fit underneath a Muscovy duck, but 12 - 15 should fit easily.

Chickens can also be used to incubate duck eggs and vice versa. Because duck eggs are larger than chicken eggs a chicken will only be able to incubate 8 - 11 duck eggs at most.

### 3.2 Some info on hatching in an incubator

An incubator is a box with trays inside on which the eggs can be put. An incubator must be able to take the place of a female duck. It must keep eggs at a constant temperature, right humidity and proper ventilation..

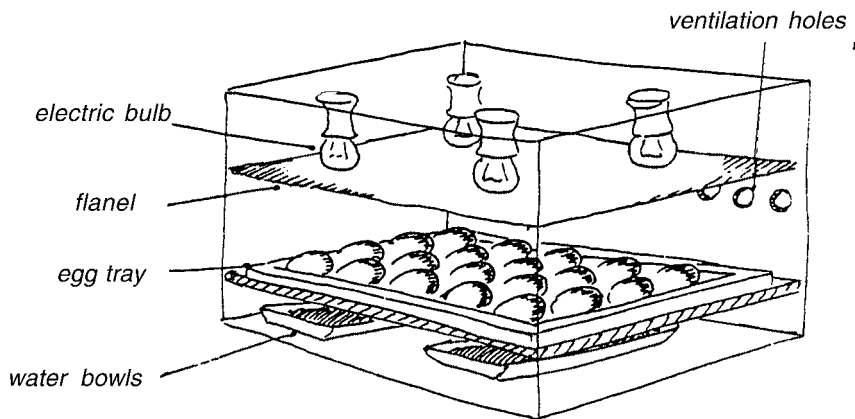

Figure 7: A small incubator

Incubators come in many different shapes and sizes, it is possible to make a small scale incubator yourself. Using incubators and making them is described extensively in Agrodok 34 ‘Hatching eggs by hens or in an incubator’. Although the Agrodok is mainly about chickens, much of what is written also applies to ducks. The text indicates where ducks have different requirements. Figure 7 shows an example of a simple incubator.

*Table 1: Artificial incubation of duck eggs*

Day in incubation period	Temperature	Number of times to turn per day
01 – 24	38	5
24 – 26	38	5
26 – 28	37.5	0

The temperature needs to be about 38°C (see table 1). If the temperature is lower or higher the duckling will not develop properly. At best the ducklings develop too slowly but will hatch. In the worst case, the ducklings die before they hatch. When ducklings hatch they need a temperature of about 30 - 32°C. In colder areas you can reduce the temperature by 1°C each day afterwards.

An incubator needs good ventilation and must be able to maintain humidity. The air humidity must be quite high, although at the beginning of the incubation period it must not be too high. This is because part of the moisture in the egg needs to evaporate, otherwise the embryo will drown in the egg fluid. If it is too low at later stages it may result in eggs becoming too dry.

**Length of incubation:**

Nearly all types of ducks take about the same amount of time to hatch their eggs. Generally duck eggs need to incubate for between 25 and 28 days before they hatch. You can expect most breeds to take about 28 days. Muscovy duck eggs take longer to hatch - about 35 days, and Mule duck eggs usually take about 32 days.

## **Advantages of producing eggs artificially**

- A lot of eggs can be incubated at the same time. May be even enough to allow you to sell day-old ducklings to others.

## **Disadvantages**

- Investments are needed to buy or build an incubator;
- Time is needed to vigilate the process, to make sure the temperature and humidity are at the right levels and that nothing goes wrong with the heat supply;
- In case you choose an electrical heat source, power cuts can easily result in a disaster;
- Artificial incubating requires experience, especially in the beginning the risk of eggs not hatching or ducklings dying is very big.

## **Conclusion**

If you do not incubate more than 100 eggs at a time (one production cycle) it is not worth risking so much effort and investment. In most cases you make the best of things letting the female ducks do the job they are very good at: incubating their and other's eggs and taking care of the ducklings.

Artificial incubation can best be left to professionals who make it their job to market ducklings and day-old chicks. They can turn to Agrodok 34 for information on incubator construction and management.

## **3.3 Selection in flock traits**

The time of hatching is an important moment for selection in your flock. By selecting eggs you determine the traits of your future flock. Eggs from good layers will in general produce good layers. Broodiness, feather colours and body traits will inherit also. Good layers will not be broody very often.

If you make use of the difference in broodiness of different strains or individuals, you will breed more layer ducklings in the end. You select

eggs from the best layers (or other traits) and replace the eggs of the broody hen by them, as soon as she sits permanently.

### 3.4 Sexing ducklings

Sexing can best be done at this moment so that you can separate the drakes from the female ducks.



*Way of holding the duckling*

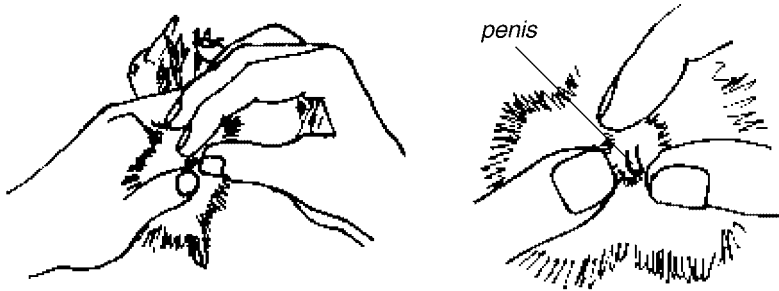

*Press thumb and first finger tightly together over vent.  
The part them slowly so that the vent is fully extended and exposed.*

**Figure 8: Sexing newly hatched ducklings**



It is useful to know what sex the ducklings are in order to be able to separate the ducks from the drakes. This will make your production more efficient. If you sex newly hatched ducklings you can sell the drakes as day-old ducklings.

Once the ducklings have dried after hatching you can sex them. By holding the duckling as shown, it is easy to see whether or not it has a penis. It is easier to do this with ducks than with chickens and after a little practice you will become better at this. This method is vent examination.

#### Methods for sexing at a later stage

If you want to rear the ducklings until they have been fattened and then sell them you can also use one of the other methods:

➤ Watching the colours of the feathers

Ducks and drakes of some breeds have different colours which makes it easy to tell them apart.

➤ Voice

There is a clear difference in the noise made by ducks and drakes. This is noticeable from about 4 - 6 weeks of age. A female duck makes a clear 'quack' sound, while a drake makes a deeper and more hoarse sound.

➤ Tail feathers

The tail feathers of most fully-grown drakes have a clear curl at the end. Female ducks do not have this. The only breed that does not show this distinction is the Muscovy duck. However Muscovy drakes are much bigger than the females, so it is also easy to determine sex in this breed.

### **3.5 Caring for the ducklings**

Ducklings, which have been hatched naturally, require sometimes protection. The duck that hatched them will look after them until they are old enough to look after themselves. But not all predators the duck can deter. Sometimes duck and ducklings must be kept enclosed during the first weeks for protection against predators.

Day-old-ducklings you buy (hatched in an incubator) need extra attention. You need to pay attention to warmth, water/feed and ventilation.

Newly hatched ducklings cannot maintain their own body temperature so you have to keep them warm. The most favourable time for raising ducklings is during the rainy season. During the first 10 – 14 days ducklings are kept in several baskets with about 5 cm of rice husks or straw at the bottom of the basket. This is changed frequently to keep the ducklings dry and comfortable. The basket is covered with a loosely woven jute bag to protect the ducklings from cold at night. The ducklings are kept at about 28 °C for the first 10 – 14 days.

Ducklings start eating one day after hatching and they grow rapidly. They are fed boiled rice, broken rice, rice bran, oil cake, chopped earth worms, snails, fish, green vegetables or water plants and crushed wheat. Feeding is done in a separate (single) basket. After feeding they are put on a dry jute bag or on a layer of husk or straw in a separate basket until they have dried off. They are then returned to their original baskets.

As an alternative to the basket you can choose a circular chicken wire floor covered with straw and an external heat source. You can keep them close to the heat source by bending a flexible board around the ducklings in a circle (see figure 9). Elevate the wire floor from the ground to improve ventilation and to remove manure.

The heat source can be a stove with slow burning sawdust or an electrical lamp shining in a clay pot or an infra-red lamp as in figure 9. You can tell whether the ducklings are too warm or too cold by how they behave. Figure 9 illustrates how ducklings react to the warmth of a lamp. When they huddle close to each other they feel cold: the heat source is not close enough. When the temperature is too high the ducklings will try to get as far away from the heat as they can. If the ducklings move freely throughout the cage then the temperature is right for them.

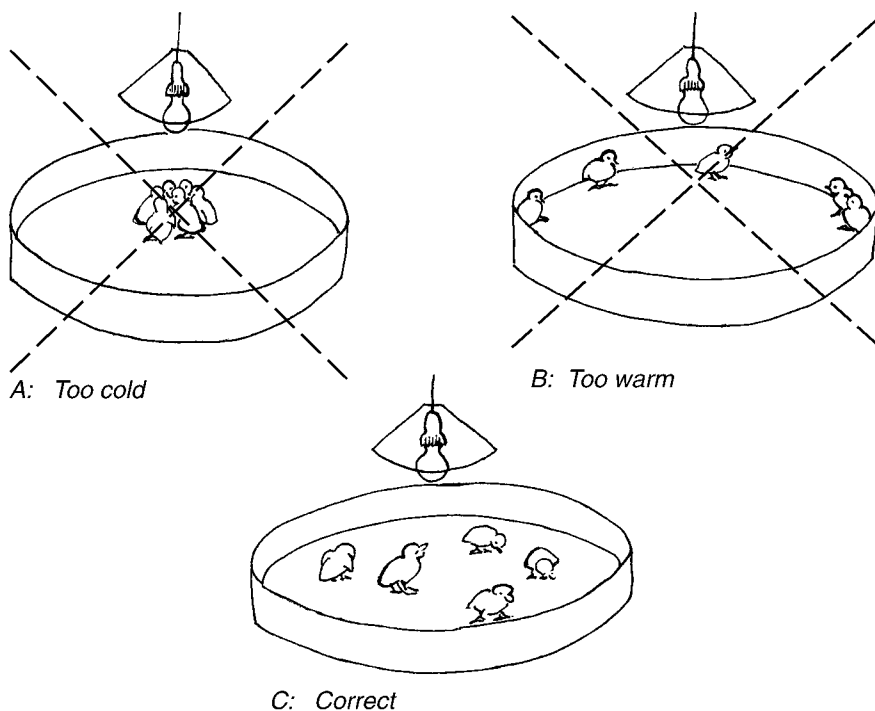

**Figure 9: Reaction of ducklings to heat source**

From about 2 to 4 weeks the ducklings are kept on rice husk or straw with plenty of fresh air and sunlight. During the day they are kept confined and provided with a mixture of feed and clean drinking water. Simple bamboo containers are used for feeding and watering. From 4 to 8 weeks the ducklings are provided with 0.30 x 0.30 m floor space per bird. In the morning they are given clean water and a mixture of feed. After some minutes of feeding, they are allowed to forage in safe (water) areas. They are brought back to the house before dark. A small quantity of feed is given before putting them inside the house. This encourages the ducklings to return home with their caretaker.

## **Drinking water**

The presence of drinking water is very important for ducklings. There must be sufficient, clean water present, otherwise the ducklings will become sick.

You have to make sure the ducklings do not try to swim in their drinking water. This not only makes the water dirty, but it can also make the ducklings sick. Adult ducks have a layer of fat over their feathers which prevents the feathers from getting wet. In a natural situation a mother duck will also rub fat into the feathers of the ducklings that she has hatched herself.

The feathers of ducklings from an incubator do not have fat over them to begin with. Ducklings cannot rub fat into their own feathers until they are about three weeks old. This is not a problem as long as they do not try to get into water. You can stop them from sitting in the drinking water by putting stones in the bowl or putting chicken wire over the top.

## **Feed**

Newly hatched ducklings need special feed. You can buy this or prepare it yourself. There is more information about feeding ducklings and preparing feed in Section 7.5.

## 4 Duck keeping systems

There are many ways in which you can keep ducks. In Section 4.1 we describe the main systems of keeping ducks, to give you an idea of the possibilities. In practice farmers can adapt these types to their own needs and the materials available.

Duck keeping combines well with other forms of farming. Section 4.2 covers two well known integrated systems: duck keeping combined with rice cultivation and duck keeping combined with fish ponds. In these systems the different forms of production complement each other and the farmer will have better production and more profit:

- Waste and by-products are used, e.g. duck manure is used instead of wasted: in fishponds it is directly used for fertilizing the pond which increases fish food; in rice fields ducks eat harmful insects and snails, this is a help for the rice and at the same time the ducks get nutritious food.
- Certain inputs are used more efficiently, e.g. a fishpond is used for fish and for ducks at the same time. Ducks grow better if they have access to a pond.
- The farmer spreads risks. For example if the rice yield is low there is still a yield of eggs and duck meat.

### 4.1 Duck keeping systems - extensive or intensive

#### **Free range system:**

The ducks are only kept enclosed at night. During the day the ducks are free to roam outside in search of food. They are brought inside at night by putting some extra food in the shelter. The ducks only require night shelter and nests for laying eggs. Ducks will stay around the place, provided you treat them well.

An advantage of this system is that the ducks go to the feed and harvest it themselves. This way, nutrients become available that the

farmer cannot reach otherwise. Some farmers in Asia herd their flocks to graze large areas after the rice harvest.

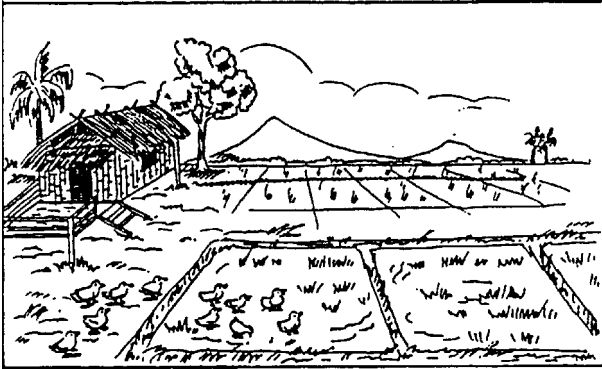

*Figure 10: Free range housing system*

**Confined system:**

The ducks are kept enclosed permanently, either in a covered shelter (indoor system) or with a run in the open. The ducks stay in the same place. It is easy to keep and eye on them and check them. An outside run makes it easier to give the ducks access to water, as a pond can be put in the open run area.

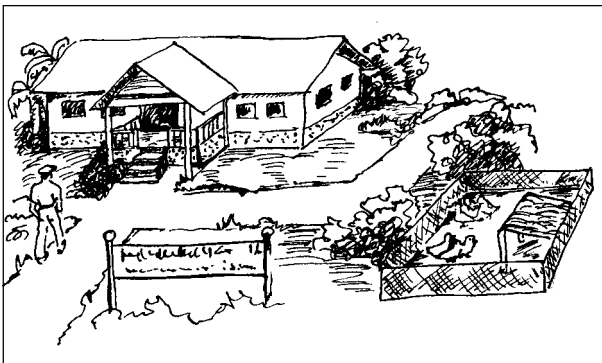

*Figure 11: Confined housing system*

### **Indoor system:**

The indoor system is for large-scale duck farms, where the production is mechanised to reduce labour costs. The system requires more investment than the other two systems of housing. Not only do you need to build the shelter, but you also have to provide all feed and water and clean it regularly. If properly managed, growth can be fast and production cheap.

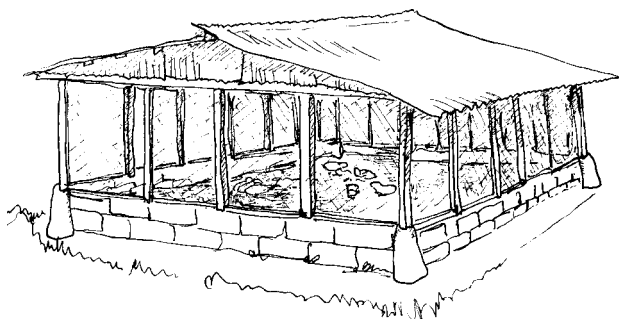

*Figure 12: Indoor housing system*

In an indoor system you cannot provide access to water where ducks can swim. But you can provide a large shallow container with water so that ducks can wash and bathe. Like open drinkers they should be located over a drained area covered with wire or slatted floor.

### **How to choose the system that fits best in your conditions?**

Your objectives will determine which system you choose. It is recommended that you start with a small flock and test the system of your choice and the potential of the market.

In a free range system you may lose your ducks easily to predators or thieves; while in an indoor system financial inputs may be substantial.

## 4.2 Combining duck keeping with rice cultivation

In Southeast Asia, duck keeping is often combined with rice cultivation. A flock of ducks can easily be kept on a rice field. Ducks feed on snails, insects, larvae and weeds in the rice fields, thus keeping pests down. However, ducks will find little food in rice fields where chemical insect killers and weed killers are used. These insecticides and pesticides poison the ducks. Therefore:

Keeping ducks in rice fields is not recommended when using pesticides on your crop.

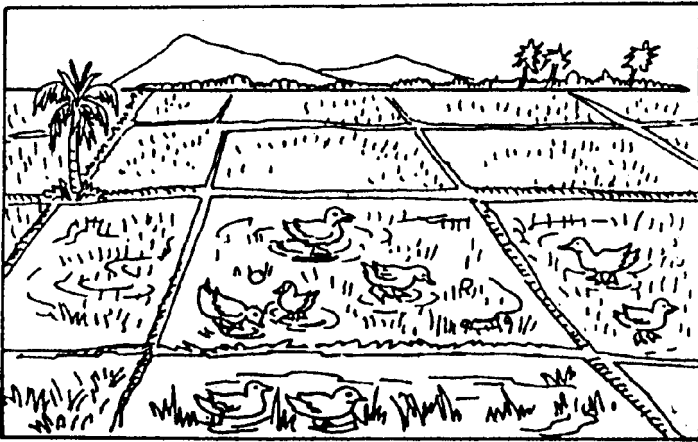

Figure 13: Duck keeping combined with rice cultivation

## 4.3 Combining ducks with fish culture

Duck keeping combines well with fish culture. Ducks profit from the pond: ducks raised in water grow more quickly than those raised on land as they are cleaner and healthier. Fish benefit from the ducks: the manure of the ducks fertilizes the pond and increases fish food (algae, plankton).



## Managing the fishpond

Managing the water quality is most important. Oxygen plays an important role in determining the quality of the water. Fish need oxygen. Water plants (especially algae) produce oxygen with the help of sunlight. At night they use up some oxygen again. Micro-organisms that break down the manure also use oxygen. Duck manure fertilizes the water plants and stimulates the growth of the micro-organisms.

If there is too much manure, the algae grow fast and the water becomes dark green. The many algae will use oxygen at night and so will the many micro-organisms that break down the manure. The result is an oxygen shortage and the fish will die. Leading to more micro-organisms in the water and even less oxygen. See also Agrodok 21: 'On-farm-fish culture' for more information.

From the above it is clear that you should keep a close eye on the water quality. An easy practical way of testing is given here:

### Testing the water quality

A simple test to check the water quality is to put your arm into the water until the elbow. If you can still see your hand, there are not enough algae and the pond needs more fertilizer. If you can see about half of your arm then there are enough algae in the water and the water quality is good.

If you can hardly see your arm at all, then there are too many algae in the water, you should stop adding manure to the water, possibly add fresh water or aerate the water through stirring.

Ducks stir up the bottom of the pond when looking for food. This reduces algae growth as sunlight cannot penetrate so deep into the water. By keeping the ducks in one half of the pond only, algae can grow in the other half. The banks of the pond have to be fenced off so that the ducks do not destroy them. This too will keep the water clean.

## Housing for ducks

Ducks only need shelter for resting. Generally speaking a minimum area of 0.5 m<sup>2</sup> per duck is required.

Ducks can be housed in a variety of ways. A pen can be built which floats on the water, or resting on stilts above the water or on the bank

of the pond. A shelter built above the water must have a floor of slats, which will let the manure through (see figure 14 and Chapter 5, Housing). Ideally all the manure should fall into the water. By fencing off the banks with wire or netting, and not allowing the ducks to roam on the banks you can ensure that all manure is deposited in the water, and that the banks remain undamaged.

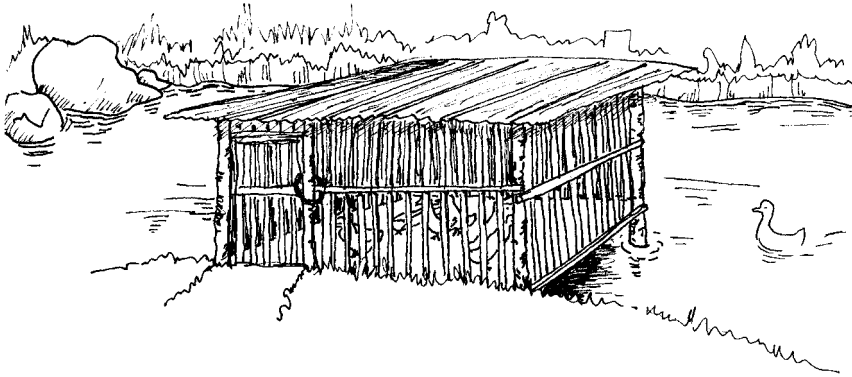

*Figure 14: Ducks above a fishpond*

### **Managing the system**

Most fish species take about 6 months to reach market weight. In order to ensure that the manure supply remains constant it is best to keep different (duck) age groups at the same time. Either separated in age groups by a fence or all together.

Once the fish has been harvested the pond will be empty of fish. Now it is unwise to add manure to it. Try to avoid this by growing small fish before you harvest the old stock. Else the ducks should be given a run in another place or you cover the slatted floor and start a deep litter on it. Schedule the harvest of the fish and the duck production carefully.

After four or five years the pond needs cleaning. The manure remaining in the pond can be taken out and used for crops or added to compost. Another way of using the manure is to grow crops in the dry pond (see figure 15). Make sure to let air in the soil by cultivating,

harrowing or plough in order to improve the nutritional minerals in it. Starting with a green manure crop. This will support the new soil structure.

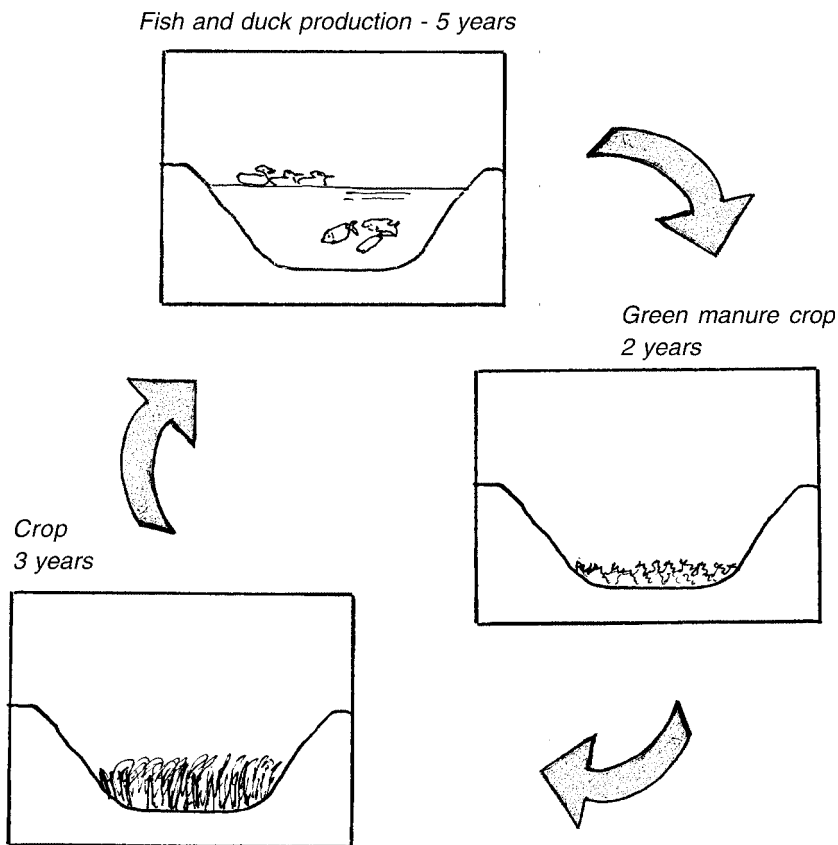

Figure 15: Growing crops in a fish pond

### Choice of fish species and numbers of fish and ducks

The fish for stocking the pond must be at least 10 cm in length otherwise they will be eaten by the ducks. It is difficult to give exact numbers of fish and ducks because the numbers are dependent on many factors. Here we only give a few guidelines. You always have to keep a close eye on the pond and on the quality of the water. You have to

try out and adjust the numbers until you have found a combination that works well in your situation.

**Different fish species can be raised together with ducks:**

➤ *Carp*

Different sorts of carp can be kept in combination with ducks. The stocking density is 45 to 60 fish per 100 m<sup>2</sup> water surface. Possible combinations of different sorts of carps, per 100 m<sup>2</sup> are:

*Table 2: Possible combinations of different sorts of carps*

Combination 1	Combination2	Combination 3
24 catla carp	18 catla	9 catla
18 rohu carp	18 rohu	12 rohu
18 mrigal carp	12 mrigal	9 mrigal
	12 common carp	12 common
		9 silver carp
		9 grass carp

When common carp are raised on their own, the density can be up to 200 fish per 100 m<sup>2</sup>.

➤ *Tilapia*

The stocking density of tilapias is 100 to 200 fish per 100 m<sup>2</sup> .

➤ *Catfish*

Catfish are not very sensitive to oxygen content in the water, they can breath in oxygen from the air as well as from the water. Because of this their density can be quite high and they are less sensitive to the amount of manure. A density of 400 fish per 100 m<sup>2</sup> is possible.

Where fish production is integrated with ducks you can obtain yields of 30 to 55 kg fish per 100 m<sup>2</sup> per year.

### **Number of ducks per pond**

Where tilapias are raised (200 fish per 100 m<sup>2</sup>) a maximum of 35 ducks per 100 m<sup>2</sup> water surface can be kept. For carp and catfish a maximum of 70 - 75 ducks per 100 m<sup>2</sup> can be reared.

The numbers of ducks and fish in a pond depend on many different factors, you have to try out, watch closely and register your observations. Change the following factors in different tests and find the best combination:

*Table 3: Trial and error factors for balancing production*

Amount of fish
Kind of fish
Amount of ducks
Duck feed
Part of the water fenced to keep out the ducks

# 5 Housing

When you choose to keep ducks you have to provide some kind of shelter for them. Ducks lay their eggs during the night and in the early morning (within three hours of sunrise). By keeping ducks inside at night you can ensure that they lay their eggs in a confined space.

Nesting boxes are not necessary, but if you provide them the ducks will use them. An advantage of nesting boxes is that they are easy to clean. Eggs laid in nesting boxes will be cleaner, and eggs which look clean are easier to sell than dirty ones.

## 5.1 Night shelter

Housing for small-scale duck keeping should not require too much care and maintenance. A night shelter should be sufficient and does not require much space per duck:  $1\text{ m}^2$  is enough for five to six ducks. If the ducks are going to make use of the shelter during the day as well, then they need more space. In that case  $0.5\text{ m}^2$  is needed per duck.

It does not matter what kind of material you use to make the shelter: Bamboo, wood or chicken wire are all fine as long as the holes are small, so the ducks cannot go through.

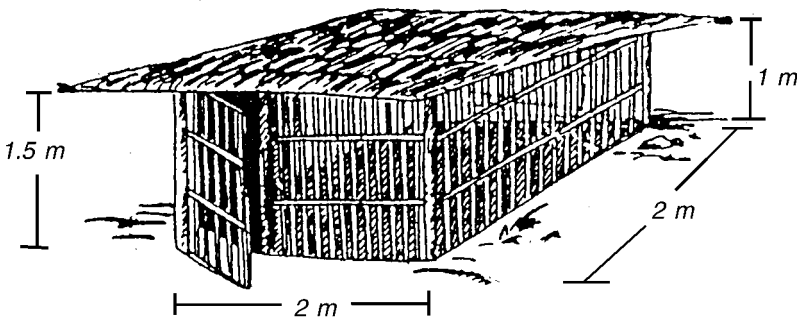

Figure 16: Night shelter for 20-25 ducks

The shelter must be well ventilated when the ducks are inside. Fresh air is important to prevent the ducks developing respiratory problems. Diseases which are spread through the air can be prevented by good ventilation.

Air circulation in the shelter makes the temperature lower. The temperature should not be lower than 10 - 15°C for Peking ducks or 20°C for Muscovy ducks and other ducks from tropical climates.

## 5.2 Separate laying area

It is very convenient to make a separate laying area within the night shelter. Ducks prefer to lay their eggs in a dark, protected space. Nesting boxes offer ducks a sheltered place to lay their eggs. The eggs laid in these boxes are easier to collect.

Ducks prefer to lay at ground level so you can place the construction on the floor. It is best to attach the construction to the back wall of the night shelter. In this way the ducks can sit quietly, away from the rest of the flock, when they are laying.

When building nesting boxes you need to make one box for every three to six ducks. A simple construction is one with side walls of 30 x 35 cm. Assemble these at a distance of 33 cm from each other. Attach them to each other at the back by means of a raised edge 15 cm high. Attach a raised edge of 5 cm height at the front.

Place straw in the nesting boxes and clean them regularly.

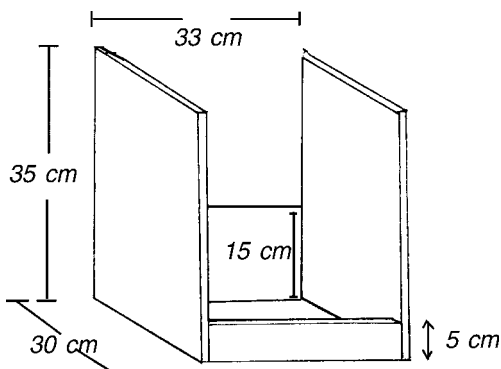

Figure 17: Nesting box

## 5.3 Floor

The type of floor depends on where you place the night shelter. If you build a night shelter above water, the floor can be made of open slats using wood or bamboo. It is not a good idea to use chicken wire or a metal grate as these do not give the ducks' feet enough support, and can damage their feet. Floor slats should be 2 cm thick and 5 cm wide in order to be strong enough. Leave about 1 cm between the slats. These gaps will ensure that there is sufficient ventilation at night. Another advantage of these gaps is that spilt food and droppings will fall straight into the water, whereas the eggs will stay in the shelter. This makes cleaning the shelter easy and it fertilises the pond below.

If you cannot build the shelter over a pond then the floor does not need to be slatted. You will have to clean out nest material and manure more often to prevent diseases from spreading.

### **Deep litter system**

On a closed floor the litter may sit for some time while a new lot is spread every day. Litter prevents dirt and dampness from forming a hard layer on the floor. Straw or rice chaff make good litter. Sawdust can also be used for litter, but you must make sure that there is no paint in the sawdust as this can poison the ducks. It is best in combination with longer fibre. Any fibre will do as long as it is dry and organic.

The litter must be kept clean by replacing it regularly, especially in the nesting boxes. Litter that is damp and mouldy not only causes sickness in the ducks, but damages the eggs so that they rot or do not hatch. Ducks are very sensitive to mould in litter. Use this litter in the compost heap

## 5.4 Feeding troughs

Ducks kept in a free range system do not need much equipment for feeding. Scattering the correct amount of feed on a clean spot each evening is sufficient. If you decide to feed the ducks when they are in the night shelter then you need to use containers for the feed. This way



the food stays clean and the ducks do not trample on it. Ducks are very messy eaters. If you put food in containers you must make sure you can clean the area around them easily.

A large bowl with a flat bottom or a hollowed out tree trunk as shown in figure 18 can be used for feed.

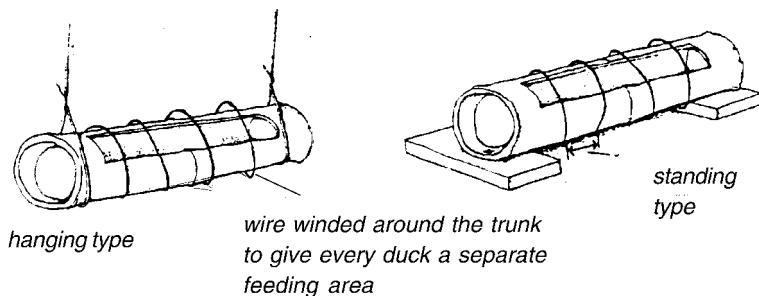

**Figure 18: Feeding troughs**

To prevent spillage you can use a feeding trough like the one in figure 19. The anti-waste lip prevents a large amount of the food being spilled.

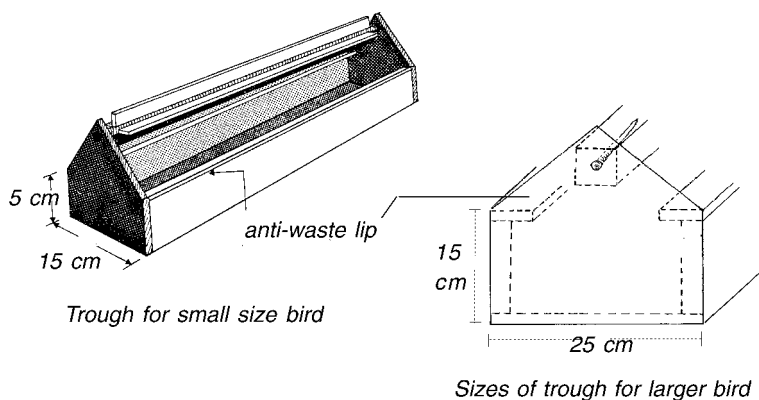

**Figure 19: Troughs with anti waste lip**

You can adjust the sizes of the trays to the size of the bird.

Sometimes wild birds will eat out of the feeding troughs. To prevent this food waste, place a low roof over the feeding trays. Wild birds will not usually go under such a low roof.

*A: Earthen pot upside-down with a little hole just under the edge .*

*B: Bottle, opening of bottle should be under the water level. Fill the bottle completely before putting it upside-down. Put pebbles in the tray.*

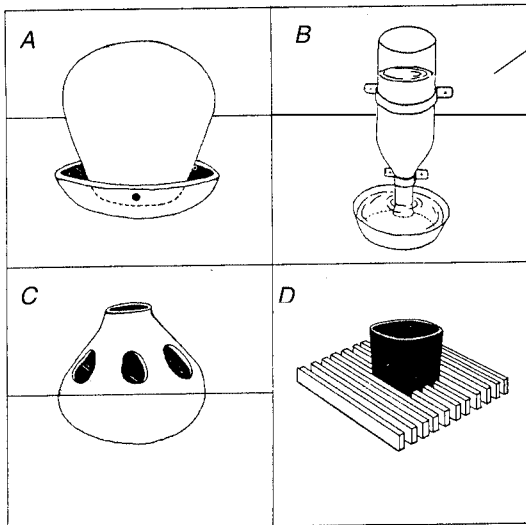
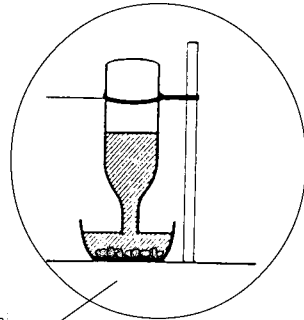

*C: Gourd, with holes through which the ducks can drink.*

*D: bowl, secured in wooden tray so it can not be pushed over.*

*Figure 20: Drinking systems*

## 5.5 Drinking water systems

Ducks need water day and night. By making a pond, or putting down a bowl of water you solve the problem of access to water during the day. It is very important that ducks always have access to clean drinking water. Young ducks that do not get enough water will not grow well

and will become sick. Adult ducks that do not have enough water will lay fewer eggs. A serious water shortage will kill ducks (and ducklings) quickly.

As with the feed trays, put water in shallow bowls that do not tip over if a duck stands on the edge.

Check the water bowls once or twice every day to make sure that there is enough water and that it is clean. Figure 20 shows some types of water container that prevent the water from becoming dirty quickly. It is important that the ducks cannot immerse themselves in their drinking water, as that makes it dirty very quickly. However, the water must be deep enough for the ducks to be able to put their heads under water. They need to do this to clean their eyes. If they cannot do this dirt becomes caked around their eyes, and in extreme cases this can lead to blindness. Ducks also use their drinking water to clean food remains off their beaks.

## **5.6 The importance of water**

Give ducks access to water for cleaning in the form of a pond or a puddle of clean water, or even just a large container with water in it. If it is not possible to keep ducks near water the whole day it is sufficient to place a tub of water out (drained stone or slatted floor) for them in the mornings and evenings so that they can keep themselves clean and therefore more healthy. Avoid putting water on top of the litter without draining what spills, as the litter must remain dry as possible.

Different sorts of ducks differ in their water requirements. Peking ducks need water to keep their body temperature at the right level. This is not so necessary for Muscovy ducks as these are originally tree-dwellers. Some types of duck also need access to water to mate.

Remember that water can be a source of disease and vermin. Pools, ponds, troughs or tubs of water all need to be kept clean and hygienic.

## 5.7 Daily care of ducks

When the housing is arranged well, including feeding troughs, drinking water equipment and access to bathing water, you can then acquire ducks. In the chapters before, choice of breeds, breeding and raising and caring for ducklings have been treated. Also different systems have been discussed and you must have chosen one.

Following on from this chapter you find information on health care, feeding and the products.

The overview below provides a short summary of daily care in order to give you an idea of things that need to be done.

### Daily care of ducks

#### *Morning*

- let the ducks out of the shelter
- collect the eggs
- give fresh drinking water
- If there is no pool of water, put out fresh bathing water.
- clean the shelter and repair if necessary
- sell the eggs if you wish

#### *Evening*

- scatter fresh straw or rice chaff if litter is wet
- give ducks fresh drinking water
- feed ducks
- shut ducks up for the night

*Anytime:* Watch your ducks to see how they feed in order to notice any other problems. See also Chapter 7.

# 6 Health care

## 6.1 Preventive health care

Health care for ducks does not require much time. In contrast to chickens, ducks are less likely to become sick and are susceptible to fewer diseases than chickens.

In order to know whether a duck is sick you first have to know how a healthy duck looks. Table 3 lists the most important characteristics of healthy and unhealthy ducks.

*Table 4: Main signs of health and illness in ducks*

Characteristics	Healthy ducks	Unhealthy ducks
General condition, first impression	Lively	Listless, unusually quiet
Weight	Good	Often light
Growth rate	Normal	Too slow
Eyes	Lively, bright	Listless, dull
Cloacae (genital / anal area)	Large, soft, moist, pink	Shrivelled, dry, discoloured
Skin	Soft, loose	Wrinkled, dry

The most important information in this table tells you how to recognise a healthy duck: how it should be growing, how the eyes and cloacae (genital/anal area) look and how the skin feels. A good way of becoming familiar with how a healthy duck looks is to regularly study ducks for a short while. This does not mean you have to pick up each duck every day, but just spend about 10 minutes observing the flock wandering around, noting how the ducks look and whether they are eating well. Make a note of what you see.

## 6.2 Preventive health care

Good hygiene and vaccinating ducks are the two most important aspects of preventing ducks becoming ill.

## **Good hygiene**

The most important factor in good health care for ducks is: good hygiene. By keeping the shelter and its surroundings clean you reduce the chance of disease breaking out. Good hygiene practices also keep vermin like rats, but also flies and lice, away.

It is more difficult to keep an eye on free range ducks: what they come into contact with and exactly what they eat. Ducks can also become sick from contact with buckets or crates which may contain traces of diseases. It is important to know that dirty drinking water and food can be a cause of sickness.

Important measures in good hygiene:

- Keep the shelter and outside run as clean as possible.
- When a whole flock is removed (all-in-all-out system) after a laying cycle or fattening cycle, take the time to clean the shelter really well and disinfect it. Remove all the old litter and use it for compost. Clearing litter regularly reduces the chance of disease and sickness in the shelter and infecting the ducks.
- Keep an extra sharp eye on sick ducks. If possible keep sick ducks separate from the healthy ducks. This prevents the disease from spreading to other ducks or even chickens.
- As soon as many ducks become sick, or the disease symptoms become much worse, or ducks start to die you must take measures to prevent the healthy ducks becoming sick. Dead ducks must be removed as quickly as possible, not only because they are infectious, but also because they will start to rot and attract flies. Flies transmit diseases.

## **Vaccinations**

Some diseases are so infectious or so common that it is worth vaccinating the ducks to protect them. If duck keeping is very common in the area where you live it is especially worthwhile vaccinating your ducks. It is best to obtain information on the subject from a local veterinarian.

## 6.3 Diseases

If your ducks become sick despite preventive measures, there are a number of things you can do. Many diseases can be treated with medicine, which you can get from a veterinarian. If you know local medicines, which are used to treat chickens, you can also try them on ducks. A common preventive measure taken in India is to mix garlic into the duck feed. You need one clove of garlic per duck per day. Turmeric also works well. Both of these spices can affect the flavour of the meat and eggs, so do not use too large quantities.

Below we describe the most common duck diseases. These are intended to give you an indication of the main symptoms. If there are serious problems, or if certain problems keep coming back, then ask advice from a veterinarian.

### Botulism

#### *Symptoms*

If there is botulism in the flock a number of ducks will become paralysed very quickly, and then die. In the first stage the neck, head and legs become quickly paralysed. An sign is that a sick duck will lay its head down on the ground because it can no longer lift it up. Once general paralysis has set in death follows in a few hours.

#### *Cause and treatment*

Botulism is caused by *ducks eating* food which is *rotting*. *Botulism* is caused by bacteria which are present in rotting plant remains, animal remains and also in stagnant water. During long periods of warm weather the risk of botulism rises as the bacteria can reproduce themselves more easily. Botulism is best prevented by not letting ducks come into contact with rotting food and animal carcasses.

Once you decide a duck has botulism you can give it something which will make it vomit the rotten food out of its stomach, you must take extreme care in doing so, protect yourself by wearing gloves.

**WARNING:** botulism also affects people. Those looking after ducks which have botulism should take care not to contract the disease themselves!

Unfortunately ducks become sick and die very quickly with botulism, which means that this treatment often comes too late.

Dead ducks must be removed as quickly as possible and the shelter must be cleaned. You can disinfect the shelter by adding some household disinfectant like Dettol to the cleaning water. You can best wear gloves and change clothing afterwards and wash yourself.

### **Fowl cholera (pasteurellosis)**

#### *Symptoms*

Ducks of all ages are susceptible to *fowl* cholera. Sick ducks first become listless and lacking in energy. They eat less, but drink more than healthy ducks. They shake their heads a lot and their droppings are watery and yellow/green in colour (diarrhoea). The eyes are damp and the nostrils contain slime.

#### *Cause and treatment*

*Fowl* Cholera is passed between ducks through the slime in the nostrils which is deposited on food. Healthy animals pick up the disease from the food and become sick. You can vaccinate ducks each year against cholera. This is a way of preventing cholera.

If the ducks contract cholera despite of the vaccination then there are medicines which can be used to treat it. If your ducks have cholera you must warn the veterinarian. The disease spreads very quickly and has a high death rate (5 - 35%). Medicine is not always available, and then other measures must be taken. The sick ducks must be slaughtered and burned or buried.

The shelters and any outside runs must be disinfected well. If the shelter is not properly disinfected there is a chance that the disease will stay in the shelter and affect the healthy ducks.



It is also possible to alleviate the symptoms of *fowl* cholera. In India this is done in the following way:

- For 10 ducks mix 7 - 10 chopped cloves of garlic with the feed. Use for 2 - 3 days until the diarrhoea stops.
- Grind 10 g fresh ginger and squeeze out the juice.
- Mix this with 250 ml water and 10 g brown sugar. This provides enough drinking water for 10 ducks.
- For 10 ducks cut up 5 chilli peppers (*Capsicum annum*) into small pieces and mix them into the feed.

## **X-disease (aflatoxicosis/mycotoxicosis/cirrhosis of the liver)**

### *Symptoms*

Symptoms are seen especially in young ducklings. Infected ducklings grow slowly and feathers are badly formed. They may also have oedema (swelling due to water retention). The feet and soles of the feet may start to wither away. The liver becomes fatty and hard. It is easy to see the whitish yellow fat when a dead duck is cut open. Many ducklings die of this disease, whereas adults may show no symptoms at all.

### *Cause and treatment*

The disease is caused by aflatoxin, a poisonous substance sometimes found on groundnuts (peanuts) and products made from groundnuts. There is no medicine available to treat this disease. The only way to prevent ducklings from getting the disease is to make sure they do not eat groundnuts or groundnut products. Check what the ducklings eat if you grow groundnuts yourself.

## **Viral hepatitis of ducks**

### *Symptoms*

Viral hepatitis is a disease, which only affects ducklings. It is a highly contagious disease, which spreads quickly. Infected ducklings deteriorate quickly and die.

Ducklings with viral hepatitis walk unsteadily, and the beak and leg skin turn blue. A few hours after the appearance of the first symptoms the ducklings fall on their side and get muscle spasms. In the final stages the legs are stretched out behind and the head lies on the back. The death rate may be as high as 80 - 95%. Internally, the liver swells up and internal bleeding can be seen. The kidneys may also be swollen.

Viral hepatitis can also be recognised by sudden death of three week-old ducklings.

### *Cause and treatment*

A virus causes the disease. Ensuring good hygiene can prevent the disease, and there is also a vaccine available. The ducklings can be vaccinated, but the mother ducks can also be vaccinated. Mothers that have been vaccinated transfer their immunity to the egg yolk. The ducklings are protected for three weeks after they hatch. Once the inherited immunity has worn off they are also no longer susceptible to the disease, as it does not affect ducklings older than three weeks. If you want to vaccinate mother ducks or ducklings you should contact a veterinarian.

## **Coccidiosis**

### *Symptoms*

Coccidiosis is a disease which is hardly found at all in some areas, while in other areas it causes the death of 20 - 70% of ducklings 3 - 7 weeks old. The ducklings that survive grow more slowly and have a lower adult weight than the ducklings that were not sick.

There are usually few or no visible symptoms of coccidiosis. Symptoms may include dehydration, weight loss and inability to stand up. The only way to be sure of the disease is to cut open a dead duckling and examine the inside. In the middle part of the intestine there will be a slime layer with blood spots. With a microscope it is possible to see banana-shaped organisms in the stomach contents.

### *Treatment*

Once the ducklings are sick it is difficult to treat and cure them. There are medicines which prevent coccidiosis. These can be mixed with the feed. Ask the veterinarian for advice.

## **Duck virus enteritis**

### *Symptoms*

Affected bird is reluctant to walk, feathers are ruffled, watery greenish-yellow diarrhoea, haemorrhages of internal organs.

### *Treatment*

It is difficult to treat and cure them. Ensuring good hygiene can prevent the disease. There is also a vaccine available.

## **Riemerella anatipestifer**

### *Symptoms*

At the age of 2 – 9 weeks, listlessness, ocular discharge, greenish diarrhoea, in-coordination, tremors of head and neck, air sacs are layered with dry caseous exudates.

### *Treatment*

Sulfadimidin and antibiotics at beginning of outbreak, vaccination of parent stock, prevention of scratches and wounds.

# 7 Feeding

## Free range systems

Ducks can graze and digest local food easily: snails, water weeds, grass, small fish, shellfish and insects. They will get enough protein and vitamins from it. In addition they need energy. You can supplement the ducks' food with energy-rich foods such as rice, cassava (by-products), sago, sweet potato, etc. You can use this extra food to encourage the ducks to come inside in the evening.

## Confined systems

Ducks kept inside (confined) cannot look for their own food, and are therefore dependent on what you feed them. The best is feed specially made for ducks. These are complete feeds and you do not need to add anything to them. If you want to feed the ducks more cheaply you can replace one third of the special feed with vegetables (leftovers), household waste and other feeds such as sweet-potato tops, water plants such as kangkong (*Ipomea aquatica*) and duck weed. You can also make duck feed yourself, which is explained in Section 7.5.

## 7.1 Drinking water

Ducks need water in order to be able to absorb nutrients from food and also to eliminate toxic substances from the body. Water is also needed to maintain a constant body temperature, it is particularly important when the weather is warm. Ducks pant in order to lose heat and therefore cool themselves down when it is hot. Panting results in a loss of carbon dioxide from the blood and leads to respiratory alkalosis. This panting can be prevented by 0.25 – 0.5 % sodium bicarbonate to the drinking water. Other factors, which also influence the amount of water ducks require, include the type of feed they get, laying frequency and the size of the duck.

An adult duck needs 2 litres of water each day. Table 7 in Section 7.4 gives a guideline for the amount of water needed by young ducks.

## 7.2 Quantities of food

Generally speaking ducks eat as much as they need. If you notice that your ducks are losing weight, it means they are getting too little food or that they are sick. If you give them more feed but they do not eat more, it may be because the feed is of bad quality. If this is the case then the ducks will start to eat more once you improve the quality of their feed.

If you give the ducks so much to eat every day that there is always some left over then they are getting more than enough. In this case you could give them less, as food which is not eaten will start to rot quickly. If the ducks eat food which has gone bad, it may make them sick. A useful tool is registering what you feed daily by measuring (and writing down) the weight or the volume of the daily feed.

Ducks which continue to eat poorly even after you have taken the above measures are probably sick. You can find more information on duck diseases in Chapter 6.

The amount of food that a duck requires depends on the duck's age and on the use to which the duck is put (for eggs or meat). Obviously an adult duck will eat more than a week-old duckling and a duck that needs to produce eggs or meat needs more than a drake that's kept only for breeding. For more details see Section 7.5.

Ducks that get too much to eat become fat. When you slaughter a duck it should have a fatty layer on the belly, which is not thicker than 0.5 cm.

## 7.3 Nutrients in feed

Duck feed must include the following essential nutrients:

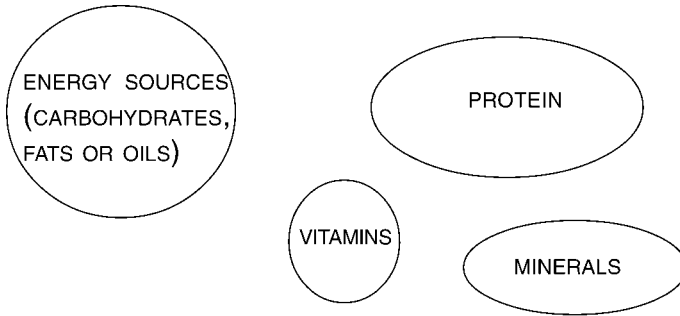

*Figure 21: The four nutrient categories*

First we consider these essential nutrients. In Section 7.5 attention will be paid to feeding methods and feed composition.

### Energy

A duck needs energy for body maintenance, movement, growth and for the production of eggs and meat. The energy in the diet is derived largely from carbohydrates, some is also derived from fat or oils.

#### **Energy rich feeds**

Feeds which are good sources of energy, include:

cassava, sago, sweet potato, yam, taro, maize, corn, rice grains, rice bran, leftover rice from cooking, molasses and fruit.

The amount of energy contained in foodstuffs is normally expressed in kilo-calories (kcal) per gram of food. Kilo-Joules are also used:

4.2 kJ = 1 kcal.

A duck that is not laying nor growing weighing 1.7 kg needs 400 kcal per day. This is only enough for looking for food, breathing and digesting food. It is called the maintenance requirement.

A duck that is growing or is laying eggs needs extra protein and energy respectively. A layer weighing 1.7 kg needs at least 440 - 490 kcal per day. A layer which also has to look for its own food all day will need more energy for movement than a duck that sits inside all day. Heavier layers and ducks, which lay an egg almost every day, need between 500 and 600 kcal per day.

## **Protein**

Proteins consist of amino acids, the building blocks of all organs, muscles and bones. So they are important for growth and for the body functions like health. Young ducks need protein in order to grow, especially in the first few weeks.

### **Protein rich feeds**

Feeds which are good sources of protein include:

young grass, vegetables, water weed, small fish, shellfish, snails, crabs, shrimps, insects, blood-meal, fish meal, skim milk powder, cottonseed cake meal, lucerne meal, soya bean, sunflower cake meal.

## **Vitamins**

Vitamins are needed (in small quantities), for various body functions. Free range ducks will get the most important vitamins they require from the green feed they eat such as young grass or vegetable remains. Ducks, which are kept inside (confined) are dependent on the vitamins in the feed they are given. In this case it is worth buying a vitamin and mineral premix. It is generally true to say that ducks which are given a varied diet including different sorts of feed will not run the risk of a vitamin deficiency.

In hot climates the biosynthesis of vitamin c is not adequate to meet normal physiological needs. Addition of 20 mg vitamin C per bird per day will improve production and health.

## **Vitamins**

Niacin, for example, is an important vitamin for growth and feathering. Laying ducks, which do not get sufficient niacin, may develop leg weakness.

Niacin is found naturally in whole grains, but young ducks cannot digest these fully.

As a cure it is possible to supplement the feed for ducklings and layers with 5 - 7% leftovers from brewing dregs from fermented millet, banana, coconut, wheat or maize. This is good for growth and preventing leg weakness. You can collect brewing dregs from places where drink is brewed. Dregs must be collected regularly though as they decompose and rot very quickly. Collect fresh dregs every other day and keep them in a clean container. For large production you can store it as a silage

Niacin (also known as vitamin B3) is also found in dairy products, fish, lean meats, nuts wholemeal bread and cereals.

## **Minerals**

The most important minerals are calcium (Ca) and phosphorus (P). These are needed for bone formation and maintenance and for making eggshells.

Ducklings need a Ca:P ration of between 1:1 and 2:1.

Ducks which are laying require a Ca:P ratio of 6:1 and need 4.0 g of calcium every day in order to be able to make the eggshells.

## **Minerals**

Foods which are a good source of calcium include:

oyster-shell grit, limestone flour, steamed bone flour and bone-meal, ground eggshells and shells.

Foods which are a good source of phosphorus include: steamed bone flour and bone-meal. Scatter powder or meal over the duck feed.

It is not advisable to make steamed bone powder yourself.

Steam does not disinfect the bones sufficiently, and the powder may make the ducks sick. Burning the bones to ashes (bone-meal) is a safe alternative.

## **7.4 Feed composition and requirements**

The composition and the quantity of food will determine whether the ducks' requirements are fulfilled. The age of the duck and the production determine its requirements.



## Feeding ducklings up to 8 weeks

Day-old ducklings can be given a mixture of coarsely milled cereals, moistened with milk or water as their first feed. After a few days they will be ready for a mixed feed, such as the following composition:

*Table 5: Duckling mixture*

milled cereal	30 %
fine cereal bran	30 %
ground soy bean	25 %
oil-cake meal extract	10 %
fine grit and minerals	5 %

Add enough water to make a crumbly mixture. If you add too much water the mixture will stick to the beaks of the ducks. Only add the water just before you give the ducks the feed. Otherwise the feed will go sour and turn bad.

If growth is unsatisfactory add a vitamin-mineral premix to the feed to make sure that the ducklings get enough vitamins and minerals.

Table 6 shows how often ducklings should be fed, the number of feeds per day decreases when the ducks grow older.

*Table 6: Feeding ducklings*

Time after hatching	Feeding:
week 1 + 2	At least 4 times a day
week 3 + 4	3 times a day
1 month	Free range: they can go out to look for insects, shells, grains and weeds. They do not need much extra feed, except in the evening to encourage them to go inside.  Confined: Ducklings to be fed 2 times a day  For both systems: Make sure that the ducklings have feed and water available throughout the day.

Remember that different types of duck will have different feed and water requirements.

Table 7 shows the feed and water requirements of growing Peking ducks. It shows that the requirements of growing ducks change rapidly. In general ducks will eat as much as they need. Check if the food is readily eaten and whether the ducks grow well. See also Section 7.3.

*Table 7: Feed and water requirements of growing Peking ducks*

Age of duckling (weeks)	Food consumption	Water consumption	
	kg/week/duck	litre/day/duck	litre/week/duck
1	0.23	0.22	1.54
2	0.75	0.60	4.20
3	1.16	0.66	4.62
4	1.34	0.68	4.76
5	1.47	0.85	5.95
6	1.63	1.20	8.40
7	1.77	1.50	10.50

Feeds which are rich in proteins are often very expensive. If feed in the form of pellets is available for chicks then this is also suitable for young ducks.

**BEWARE:** Chicken feed often contains medicines (antibiotics) which have been specially added. Do not give these feeds to ducks, as the antibiotics are not meant for ducks and will make them sick. It is best to try out a new feed by giving a very little at first to see if it is suitable for the ducks. Duck feed might also contain medicines but these are of course suitable for ducks.

**Feeding laying ducks: maintenance requirements**

A maintenance diet is recommended for young ducks between 8 and 20 weeks old, and for adult ducks between laying cycles. Young ducks needs more protein and calcium than adult ducks. If they grow too slow give attention to the proteins in the feed.

Adults will not need more than a grain supplement, where there is enough young grass available. Without young grass, a more balanced feed is required so that the ducks can build up their reserves for the next laying cycle. You can judge the amount of feed the ducks need according to their condition. If they are too fat, give them less food. If they are too thin, give them more energy.

### **Laying ducks: requirements during a laying cycle**

Free range ducks will be able to find a large amount of their food requirements outside. You can supplement the diet of free ducks with food leftovers, which contain mostly energy. In addition, laying ducks require extra calcium. You can provide this by returning the eggshells in the feed. First sterilise them by boiling in water, then grind them coarsely and mix them in some feed.

Ducks, which are kept in a confined system, can best be given layers feed from about four weeks before they start laying. If you only feed them with grain they will not get enough protein, calcium and vitamins. The best feed for this period is a mixed food, which can be home made or bought. Recipes are given below.

If you buy a specially mixed duck feed, you do not need to add anything else. The manufacturer of the duck feed has made sure that the feed contains everything that ducks need.

The quantity eaten will depend on the type of duck, its weight, egg production and the availability of grass. Laying ducks usually require between 170 and 230 *grams* per day. Good layers sometimes require as much as 280 g of dry feed per day. If you notice that the ducks are getting too heavy (i.e. too fat) it is a good idea to close the feeding troughs at night. Ducks which are too fat lay fewer eggs and are less fertile.

You can add water to the mixture to make it moist. Only add water at the time of feeding, otherwise the mixture will rot. This example gives ample feed for confined ducks. It is based on 285 g of feed per duck per day. If you give your ducks only 200 g of feed each day, this

amount will last for 10 days. How much you give depends on the size of the ducks.

Here is an example of a simple mixed feed for 20 laying ducks for 7 days:

**Table 8: Layers mixture 1**

20 kg broken rice	(50%)
10 kg rice bran	(25%)
10 kg fish meal/fish waste/bone meal	(25%)
40 kg in total	(100%)

In areas where there is abundant fresh fish, fish meal or shrimp meal you could make up the following mixture:

**Table 9: Layers mixture 2**

24 kg rice bran	(60%)
8 kg maize meal	(20%)
8 kg fish or shrimp meal (or the equivalent in fresh fish waste)	(20%)
40 kg in total	(100 %)

Add 2% cod-liver oil and 2% oyster-shell to this mixture and supplement the feed with some form of green feed (vegetable waste) if the ducks are kept inside all the time.

The following mixture is good for ducks that lay eggs with weak shells. The quantities are for 20 ducks for 7 days:

**Table 10: Layers mixture 3**

30 kg grain or by-products
4 kg fish or fish waste
4 kg pulp or fruit waste
2 kg ground shells
200 g salt + 100 g minerals

## **Fattening diet**

You can sell meat of layers, which have stopped laying eggs. Or you may choose to raise ducks specially for meat. The latter is called broiler production.

The difference in meat production between layers and broilers is that the layers are much older when slaughtered. Therefore the meat of layers is tough compared to broiler meat which is more tender. Broiler meat falls apart when boiled, it is more suitable for frying or roasting.

Depending on the type, ducks can be slaughtered when they have reached a weight between 2.8 and 3.2 kg. Check the ducks each week to see if they are gaining weight. When they are not gaining any more weight, it is time to slaughter them. There is no use in feeding ducks that are not putting on any weight. The composition (energy) of the feed will determine whether the meat will be lean or fat.

## **Summary of important aspects of duck feeding**

- Make sure there is always abundant clean drinking water available.
- Make sure the ducks get a varied diet. This will supply all essential nutrients.
- It is good to let ducks out during the day to graze and shut them up again at night (for protection).
- Always watch what the ducks do with the feed that you give them. If they leave a lot untouched then give them less the next time.
- Clear up feed which is left uneaten so that it does not rot and start to smell. If you leave the feed, it will attract rats and mice and other vermin into the shelter. The ducks can also become sick from rotting food.
- If ducks stop laying eggs, it may be for one of two reasons: 1) they may be losing feathers (moulting) or 2) they do not get enough food, or they get bad quality food, such as mouldy feed.
- If the eggshells are weak, add calcium to the feed in the form of oyster-shell or eggshell grit.

Sometimes ducks die suddenly. This may be due to one of the following:

1. Too little water. 2. Dirty water. 3. Food poisoning. 4. Sickness.

Whenever several ducks die suddenly contact a veterinarian.

Always watch your ducks carefully, taking note of their condition, health and behaviour. Do this every day. The experience you gain will help you to manage your ducks well.

## **7.5 Food poisoning**

Ducks are very sensitive to poisonous substances in their feed. All feeds may contain toxic substances. These usually occur as a result of bad storage of the food stuff, in damp or warm places. Groundnut and maize will contain toxic substances if rotten or infested with fungi.

Ducks may also be poisoned by poisonous plants or decomposing animal carcasses. This is called botulism. Make sure that all the water places that ducks have access to be free of decomposing material. See Section 6.3 for further information on this subject.

Weed killers and insecticides may also poison ducks. If ducks eat insects or plants, which have been treated, then they will eat the poison. Many of these poisons are not eliminated from the duck, but accumulate in its body. If too much accumulates then the duck will become sick or even die. Their meat is not to be eaten.

# 8 Products

Most farmers keep ducks because they want the products from them. Ducks are usually kept either for their eggs or for their meat. Some farmers also keep ducks for their manure.

In this chapter guidelines for production levels are given, and advice on care for the products in order to improve quality. Quality means fresh, clean and good tasting, but also good looking. High quality products will sell better. Therefore the effort of caring for the products is worth it.

## 8.1 Production figures and daily care

Production figures are calculated through monitoring the production levels of a duck type for some time. Because conditions are different on every farm, next figures can only give an indication of what production levels can be. Without experience it is very difficult to estimate what level of production you can expect. After you have kept ducks for a few years you will be able to make your own production estimates. Table 11 gives guidelines for a number of production figures.

Free range ducks will usually be less productive than ducks kept in confined systems.

*Table 11: Production figures for Peking ducks*

<b>Production figures for Peking ducks</b>	
Eggs per duck per year	120 - 130
Average egg weight	50 - 70 g
Incubation period	25 - 26 days
Start of egg-laying period	4.5 - 5 months
Duration of egg-laying period	12 - 18 months
Adult weight, female duck	2.2 - 3.5 kg
Adult weight, male duck	3.4 - 4.6 kg
Ratio male: female	1:4

## 8.2 Care of eggs

Care of the eggs begins the moment they are laid. Ducks usually lay their eggs early in the morning. This means that you only need to collect eggs once a day, in the morning.

It is best to collect the eggs as soon as possible after they are laid. This makes it easier to clean them, and you can cool them quickly if you need to keep them. Dirt left on eggs can cause disease to penetrate the shell and be absorbed by the egg. This causes the eggs to rot or become infertile.

### **Two methods to clean eggs:**

#### ➤ *Dry method*

Clean as much dirt off the egg with a dry cloth, brush or knife. This is a good way to remove the worst and visible dirt.

#### ➤ *Wet method*

This method is only suitable when you are selling (or eating) the eggs: Dip the eggs in warm water for no longer than 20 seconds. The water should be a little warmer than the eggs so that you can clean them well.

If you want the eggs to hatch, it is better not to wash them in water. Eggshells have small holes (pores) which open up when the egg is put in water. Diseases can enter the egg through these holes, which may mean the egg will not hatch. Once you have cleaned the eggs you need to cool them quickly.

### **Storing eggs**

You can collect and store eggs in order to sell every other day or once a week. You can also collect and store eggs so that you can incubate many at the same time. Always keep eggs which you are going to sell in a cool place. The shorter the period the eggs are kept the less important the storage temperature is.

Eggs which are going to be incubated, must be kept at a storage temperature between 13 - 16 °C. If the eggs are stored at a warmer tem-



perature (16 - 38 °C) the duckling will start to develop, but the process goes so slowly that the duckling will die in the egg.

Eggs for incubation can be stored for a maximum of seven days. After seven days the number of stored eggs that will hatch decreases rapidly. See chapter 3 for more information on incubation and hatching.

### **Management of layers and egg production**

As indicated in table 11, ducks can start to lay eggs from about an age of 5 months. Ducks which are well cared for will often continue to lay eggs for about one and a half years. The number of eggs that a duck lays also depends on good management: how much time and care you spend on your ducks. This includes all aspects of duck keeping: housing, feed and health. Table 12 gives an example of egg production achieved with 3 different levels of management:

- *Low management:*  
little daily attention paid to the ducks; a small amount of supplementary feeding is given.
- *Medium management:*  
ducks checked every day; ones that look bad are checked more often; a good amount of better quality feed is given each day.
- *High management:*  
the ducks are checked regularly; unhealthy looking ducks are checked closely and set apart if necessary; high quality feed supplement used.

*Table 12: No. of eggs produced using 3 levels of management - based on a flock of 25 duck in Thailand*

<b>Period from start egg laying</b>	<b>low management</b>	<b>medium management</b>	<b>high management</b>
first ½ year	11	14	17
second ½ year	8	12	15
third ½ year	6	9	12

Ducks lay more eggs during the first half year of their laying period than at the end of one and a half years. If all the ducks are of the same

age, and therefore start laying around the same time, you will notice that the number of eggs laid decreases after a time.

If you want a continuous production you should have a flock of ducks of different ages. Continuously you cull the unproductive ones and replace them by young layers. Depending on your duck keeping system you might also decide to use an all-in-all-out culling system. See Section 2.4 about maintaining a flock and culling.

Some ducks may even stop laying for a while. If they lose feathers and grow new ones they are moulting. This is generally a rest period for ducks. If they are well cared for they will start laying again after about six weeks. If this does not happen, something else may be wrong and you should look for other reasons why the ducks are not laying eggs.

## **8.3 Slaughtering ducks**

### **Age for slaughter**

The most economical age to slaughter broilers is the moment when the ducks are fully grown: about 8 weeks for Peking females to 9.5 weeks for Peking males, and about 10 weeks for females and 12 weeks for males of other types. When customers prefer tougher meat, then it will be worth waiting a few weeks before slaughtering.

Non-productive layers you can slaughter any time.

### **Preparation for slaughtering**

Before slaughtering a duck it is advisable not to give it food for at least six hours. Make sure that the duck has water during this time. After six hours the duck's stomach and intestines will be nearly empty which makes cleaning the carcass much easier. If the contents of the stomach or intestines come in contact with the meat, it will spoil the taste and quality of the meat.

### **Slaughtering**

If done correctly, the quickest and best method of slaughtering ducks is to cut or chop the throat. If you slaughter according to Muslim law

you must not break the neck of the duck, but cut the head off with one clean cut. After this you can let the blood drain out of the duck.

Whichever slaughter method you use, you must drain the blood out of the body in order to make sure the meat is of good quality. You can hang the duck up by its feet to let the blood drain out.

Once all the blood has drained out of the body the duck can be plucked. It is easy to pull the feathers out while the body is still warm. To make plucking easier you can also plunge the carcass into hot water (at about 55°C) for about two minutes. Begin by taking out the large wing feathers. Then pluck the back, side and stomach feathers. Do the legs, neck and the rest of the wing feathers last. You can remove any remaining stomach contents by pressing down on the front side of the duck.

In order to make a carcass look neat and ready to be sold, you can cut off the head and take out the insides if customers prefer this. If you remove the insides be careful not to break the gall bladder, as the bile will spoil the taste of the meat.

## **8.4 Manure**

Ducks also produce manure. This can be used in the same way as cow dung or manure, on the fields. When you clean out the shelter you can put the mixture of litter and droppings on a pile and allow it to decompose for one month before using it on crops. This improves the quality of manure as fertiliser material.

Duck manure can also be used directly, for example in a system where duck keeping is combined with fresh water fish farming, or where ducks are kept in a rice field. See Section 4.2 and 4.3.

# 9 Keeping farm records

## 9.1 Keeping records

It is worth keeping a record of what happens on your farm. Not every one finds keeping records easy or useful. It seems a hassle, but it is fun. Normally for a short term and for a small flock you can remember the most important information. But if you are planning to keep ducks for a longer time and if you want to make a business you need to keep track of what happens.

Depending on your type of business you can keep track of:

- how many eggs are laid every day
- how much food you give every day
- the costs you make on feeding and health care
- the investment you have made to build a shed
- which ducks are good breeders and which are not
- how many eggs you incubate and the date you have put them to incubate
- how many eggs hatch
- how many of the hatched ducklings survive and how many die

This is not a complete list, neither a compulsory list. You decide yourself of which information you keep a record, depending on the type of your business.

The information you gather can help you to make management decisions or help you to find a solution to a problem. For example:

- When you know when you put eggs to incubate, you can calculate the date that they will hatch. You can then prepare for caring for the ducklings in time..
- You can estimate when you will need to replace ducks as they reach the end of their productive period.
- When production seems to decrease in a certain season, you can look at your records for the same time in the previous year to see if this is the case. If you can be sure that production has indeed de-

creased, then you can start to look for a cause for the decrease and possibly for a solution to the problem.

- It is also worth keeping records for broiler ducks. If you keep a record of the weights (e.g. weekly) you can see quickly whether your flock of ducks is growing well and when you will take them to the market.
- By keeping a record of all the costs you have made, you are able to calculate the cost price of your products. You are also able to see if your business is profitable or not.

Just take a note book or exercise book and write down everyday what you have done. If you use a more advanced way, then you can make lists for certain topics. Design it so that it is easy for you to use and easy to find the information again.

## 9.2 Calculating the cost price

The cost price is used to determine the market(product) price. Once you have made cost-price calculations you can compare these with the income you get from the market. Then you can decide whether duck keeping is profitable for you or not.

Don't forget that your cost price should be below your market price, you have to earn something!

The outline below shows the information you need to collect to calculate the cost price.

### Variable costs

purchase of ducklings

cost of feed

petrol/electricity

health care

other (e.g. repairs on the building)

### Fixed costs

housing/shelter

equipment

Labour costs are not included but the return on the duck keeping activity should be a reasonable payment for the time you invest in it. Of

course there is a difference whether duck keeping is your main income generation or a side activity.

### **Variable and fixed costs**

The division made above between variable and fixed costs is an accounting technique.

➤ *Variable costs*

Variable costs are costs made for the daily farming activities. They change when the size of production changes or when production conditions change. Variable costs are: costs for feed; - medicine; purchase of new ducklings; energy etc. For example:

The costs for feed will double if you keep 100 instead of 50 ducks.

➤ *Fixed costs*

Fixed costs are those that do not depend directly on production activities. Fixed costs are investment costs for buildings and equipment. For example: Costs for a building will be nearly the same if you keep 50 ducks or 100 ducks.

Fixed costs you make only once for a longer period. The investment for a building is made for maybe 5 or 10 years. Repairs on the building are variable costs: Costs on repairs will be higher when the building is used more intensively.

When you calculate the cost price you calculate part of the fixed costs - the depreciation costs - these depend on the number of years the investment is planned to last. If you have taken a loan with interest, the interest rates have to be taken into account as well.

If you only want a simple overview of your costs, or if you haven't made large investments, it is not really necessary to distinguish between fixed and variable costs. You can simply write down all costs and add them up.

### 9.3 An example of calculating the cost price

To avoid confusion we have taken an imaginary type of money: M. 1M means one unit of money.

The prices used in the examples will be different from prices in your area, which means that the figures you get from your own calculations will also be different from the ones in the examples.

This example is made very simple. The aim is to give you the idea of cost price calculation.

In the example below calculations are made for one whole laying period. The ducks start to lay eggs at 5 months old and continue to lay until they are 18 months (1½ years). This means that the total laying period is 8 months (56 weeks).

*Table 13: Costs on a farm of 100 ducks - 18 months*

<b>Variable costs</b>	
Purchase of ducklings - 5M per duckling	500
Feed	1560
Electricity	15
Medicines or veterinary care	30
Litter	40
Transportation to the market	35
Sub total	2280
<b>Fixed costs</b>	
Construction of shelter, run + pool	3000

You have planned your building to last for 5 years, this means that you have to earn back 600 M per year to compensate for the investment you have made. The period you keep the ducks is 18 months, this means that over this period you need to earn back 900 M.

(For the sake of simplicity we do not include interest rates here.)

Total costs made in this laying period therefore are:

$$2280 \text{ M} + 900 \text{ M} = 3180 \text{ M}.$$

## Production

Over this laying period the total production of eggs has been: 3850  
You will also sell the meat (and possibly the manure). In the case of laying ducks the meat in fact is seen a by-product. In this example you estimate to sell 70 ducks for meat. Income from the meat is (easily) 18 M per duck. Now you calculate the costprice of an egg.

Estimated sales of meat ducks:  $70 \times 18,- = 1260,-$  M.

To calculate the price of an egg:

Total costs:	3180,- M
Income from meat:	<u>- 1260,- M</u>

Subtotal costs:	1920,- M
-----------------	----------

Cost price of an egg: $1920 / 3850 =$	0.50 M
Market price egg (20 % margin)	0.60 M

Of course you can also make the calculation the other way round. If selling eggs is less important than selling meat, then you subtract the income from eggs from the total costs. The total net costs remaining you then have to earn back by selling duck meat.

Estimated sales of eggs:  $3850 \times 0.50,- = 1725,-$  M.

To calculate the market price of an egg:

Total costs:	3180,- M
Income from eggs:	<u>- 1725,- M</u>

Subtotal costs:	1455,- M
-----------------	----------

Cost price of a meat duck: $1455 / 70 =$	20,70 M
Market price meat duck (20 % margin)	24,84 M

If you have a continuous production system in which you keep ducks of different ages together see Section 2.4 on Maintaining a flock), you can calculate the cost price per egg over a set period.

When you have bought a larger amount of feed, to feed your ducks for a longer period, be careful in calculating the cost price. If the price of



the feed has gone up since you bought it , you have to use the actual, higher price in your calculations. Because soon you will have to buy this more expensive feed again and now you already have to earn the money for it.

## **9.4 Analysing your business over more seasons**

In this example we give a production schedule of a business in an area which has two rainy seasons in a year.

The first dry season, from November to the end of January, is a little longer than the second, which is in May and June.

The longer dry season is also more severe (drier) than the shorter one. This is also reflected in the number of eggs laid each day in these two seasons.

### **Example 1**

By comparing the daily production figures (see \* in table 14) for January in Years 1, 2 and 3, you can see that the dry season was drier in Year 2 than in Year 1.

In Year 2, only 4 eggs per day were laid on average, compared with 8 in Year 1 and 7 per day in Year 3.

From your figures you would notice a decrease in egg production in January of Year 2, and you could look back at the figures for January of Year 1. You would be able to see that 4 eggs is far less, but in this case you would not be able to do much to improve the situation, as the weather is not something you can control.

### **Example 2**

In Year 3 at the beginning of March there was nothing unusual to see in your figures. However, about half way through the month the ducks started to lay less eggs. By the end of the month the average daily figure (\*\*) was lower than for the two previous years, when you compared records. By then looking carefully for the reason for this decrease in egg production, you noticed that the feed you were using for

the ducks had gone mouldy. This meant that the quality of feed had decreased and the ducks laid less eggs.

*Table 14: Analysis of egg production (flock of 20 ducks)*

Production	Dry season (severe)			Rainy season (short)			Dry season (light)			Rainy season (long)		
	Nov	Dec	Jan	Feb	Mar	Apr	May	Jun	Jul	Aug	Sep	Oct
Year 1	Daily	16	10	8*	10	16**	16	16	14	15	16	17
	Monthly	480	310	480	280	496	480	496	420	450	496	527
Year 2	Daily	16	10	4*	10	16**	17	16	14	16	17	17
	Monthly	480	300	124	280	496	510	496	420	496	527	527
Year 3	Daily	15	10	7*	11	12**	16	16	13	15	16	17
	Monthly	465	300	217	308	372	480	496	390	465	496	527

These examples show how you can use well-kept records to help you quickly check whether your production is going as you expect. After keeping records for a number of years you can also start to predict how many eggs your ducks are likely to produce.

## Further reading

Brinckman W.L., **Poultry production in tropical areas**, 1986. Larenstein International Agricultural College, Deventer, The Netherlands.

CAB International, **Manual of poultry production in the tropics**, 1987. Oxon, United Kingdom.

Dean W.F., **Nutrient requirement of meat-type ducks**, in: Farrel D.J. & Stapleton P.: Duck production science and world practice, workshop proceedings, 1985. Cipanas, Bogor, Indonesia.

French K.M., **Practical poultry raising**, 1981. IPC Livestock Barneveld, The Netherlands.

IIRR, **Ethnoveterinary medicine in Asia: An information kit on traditional animal health care practices**, 1994. 4 vols., International Institute of Rural Reconstruction, Silang, Cavite, Philippines

Jinshu J., et al., **Control of Coccidiosis in Beijing ducks with diclazuril, maduramycin, lassalocid and nazarin**, 1990. Chinese Journal of Veterinary Medicine, vol. 16, no.7, pp10-11, Beijing Agricultural University, Beijing, China.

Lee S.R., et al., **Integrated duck and fish production in Taiwan**, 1997. 11<sup>th</sup> European Symposium on Waterfowl, September 8-10, Nantes, France.

MacDonald I., Low J., **Livestock Rearing in the Tropics**, 1985. MacMillan, London, UK.

MAFF - Ministry of Agriculture, Fisheries and Food, **Ducks and geese**, 1980. Reference Book 70, sixth edition, London, UK.

Meinderts, J.H., et al., **Duck layers for daily income in rainfed rice areas**, 1986. FAO, Farm Systems Research Institute, Thailand

Perez R., **Duck-rearing manual**, 1993. CARDI/CTA, Wageningen, the Netherlands.

Pham Cong Phin, **Integrated rice-duck cultivation in Vietnam**, 1997. ILEIA Newsletter, December 1997, ETC, Leusden, the Netherlands.

Shen T.F., **Nutrient requirements of egg-laying duck**, in: Farrel D.J. & Stapleton P., *Duck production science and world practice*, 1985. Workshop proceedings, Cipanas, Bogor, Indonesia.

Smith A.J. (ed.), **Poultry**, 1992. *The tropical agriculturalist*, Macmillan/CTA, London/Wageningen, UK/the Netherlands.

Subcommittee on Poultry Nutrition, Committee on Animal Nutrition, Board of Agriculture, National Research Council, **Nutrient requirements of poultry**, 9<sup>th</sup> rev. ed., 1994. National Academy Press, Washington D.C., USA.

Van Eekeren et al., **Small scale poultry production in the tropics**, 1995. Agrodok No.4, Agromisa, Wageningen, The Netherlands.

Williamson G., Payne W.J.A. (eds), **An Introduction to Animal Husbandry in the Tropics**, 1978. pp 635-641, Longman, London, UK.

Wilson B., **Duck nutrition and feed intake**, 1991. *Misset-World Poultry*, vol. 7, no. 9.

# About WPSA

## World's Poultry Science Association (WPSA): Working together to feed the World



### Objectives of the World's Poultry Science Association

- Gather knowledge on all aspects of poultry science and the poultry industry and to bring this knowledge to the poultry industry, poultry scientists and other people with interests in poultry.
- Bring together worldwide those concerned with all aspects of poultry science, poultry production and the many diverse ancillary enterprises that are associated with the industry.
- Dedicate itself to the spread of knowledge so that education and training are ranked high amongst the interests of WPSA members.
- Promote good poultry husbandry.

### What does membership of the WPSA provide?

- 1 **World's Poultry Science Journal:** The World's Poultry Science Journal has a high international reputation for its content that covers all aspects of poultry science. The Journal is available to subscribers on the Internet, for further information and subscriptions contact: [www.cabi-publishing.org/wpsj](http://www.cabi-publishing.org/wpsj)

- 2 **World's Poultry Congresses:** exchange of knowledge and experience. Participants will obtain wider insight into the many aspects of the poultry industry not only in the field of science and research but also in the supply and processing industry.
- 3 **Congresses and Symposia of Federations:** major conferences organized on behalf of the European and Asia Pacific Federations of branches of the WPSA. The working groups of the European Federation also organize in alternate years, symposia, conferences or workshops where scientists can discuss poultry problems with people from the industry.
- 4 **Branch Meetings:** National WPSA branches hold regular meetings, produce newsletters, organize tours and are involved in supporting their national industries.
- 5 **Other WPSA activities:** The Netherlands branch of WPSA has established up a trust fund to finance scholarships. A WPSA Speakers Bureau has been set up to help foster local and regional conferences in the poultry sciences. The Association will consider applications for small scale funding support for specific aspects of conferences, which involve a group of branches or countries in a region. Examples include helping to provide a key expert speaker. Travel assistance can be provided to help young WPSA members and students participate in regional and global WPSA Conferences.

### **Address for further information**

World's Poultry Science Association Secretariat:

Dr Ir P.C.M. Simons,

PO Box 31, 7360 AA Beekbergen, The Netherlands

E-mail: [piet.simons@wur.nl](mailto:piet.simons@wur.nl)

# Glossary

Algae	- small water plants on which fish feed
broody ducks	- ducks ready to remain seated on their eggs until they hatch
culling	- to take ducks out of the flock because they are too old or sick
drake	- male duck
duckling	- young duck, up to 8 weeks old
emetic	- drug to make ducks empty their stomach, used in case of food poisoning
fixed costs	- costs that are made in an business and which don't vary every month.
gall bladder	- organ in the body in which gall is stored, gall is essential in the digestion of food
to hatch	- the breaking of the egg to let the duckling out
immunity	- inability to be harmed by a disease because of resistance within the own body.
to incubate	- to keep the egg warm untill the duckling has developed enough to emerge
nutrition	- the scientific word for feeding and how food is utilized in the body
proteins	- a nutrient substance present in foods such as meat, eggs and beans. Proteins help build the body and keep it healthy.
protuberances	- irregular swellings, outward from the surrounding body
variable cost	- costs that vary every month according to the size and conditions of production.
virus	- microscopic (very small) organism that causes diseases in other living organisms.