

SIX-ROW CAGED RABBIT HOUSE -- FLOOR PLAN

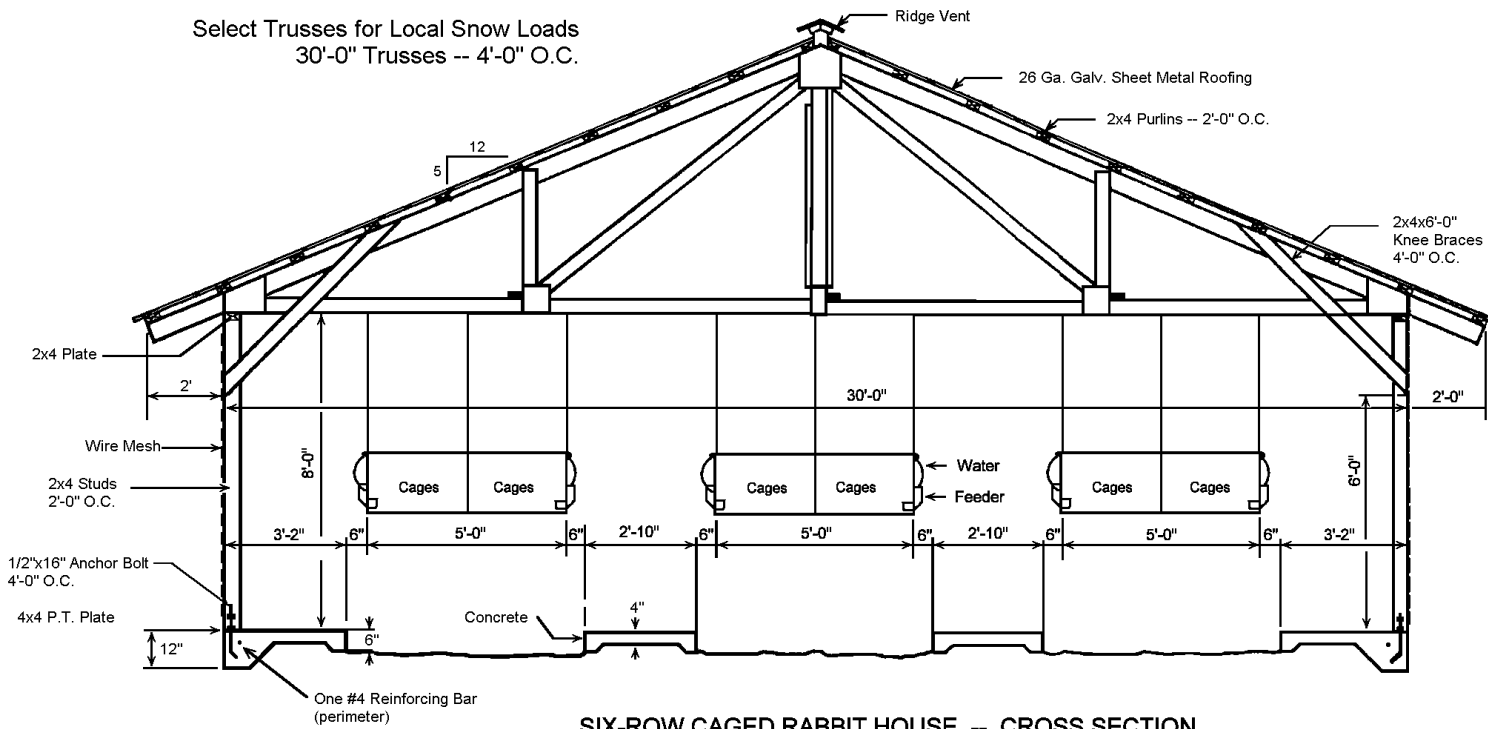

SIX-ROW CAGED RABBIT HOUSE -- CROSS SECTION

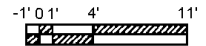
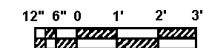

**Six-Row Caged
Rabbit House Plan
Plan 6360
Page 1 of 2**

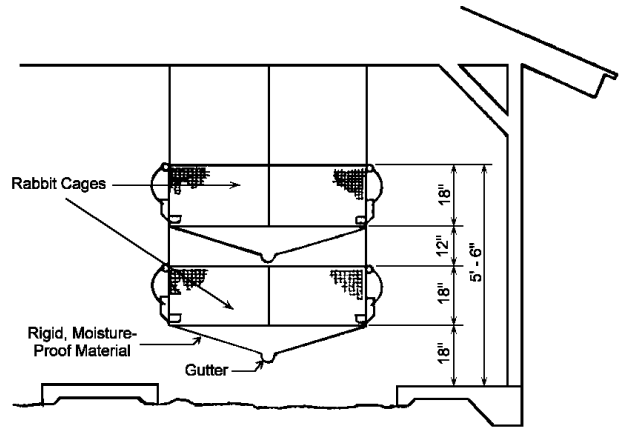

DOUBLE DECKED CAGES

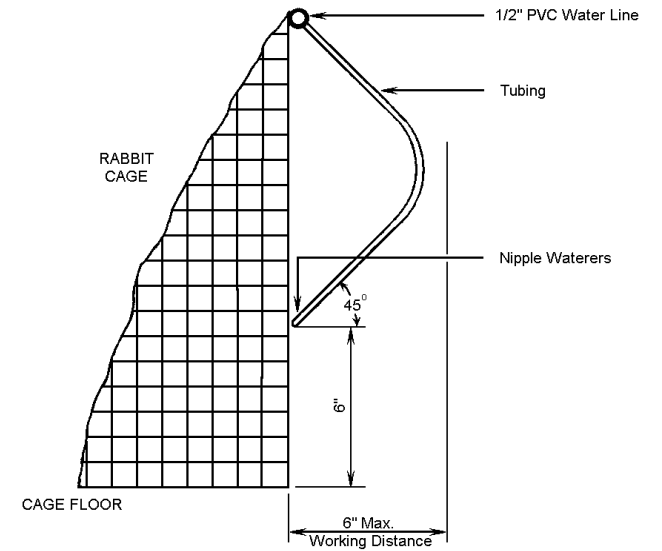
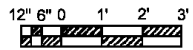

WATER LINE TO CAGES - DETAILS

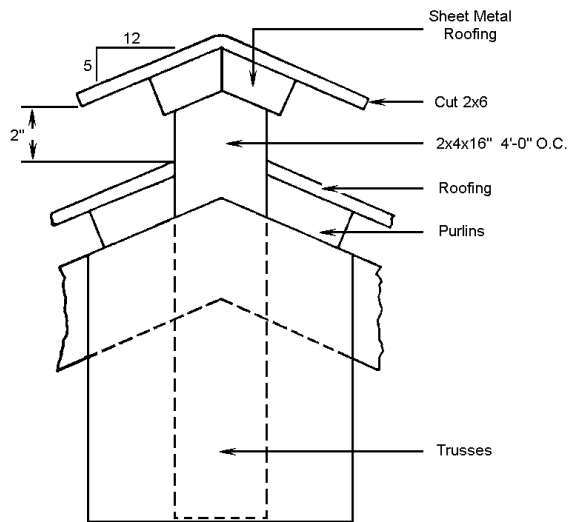
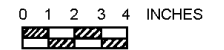

ROOF VENT DETAILS

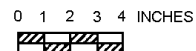

**Six-Row Caged
Rabbit House Plan
Plan 6360
Page 2 of 2**



Six-Row Caged Rabbit House Plans

These plans are for a rabbitry facility that provides six rows of cages in a single level. An equivalent of 108 - 30"x30" or 90 - 36"x30" cages for does and young plus 12 - 24"x30" cages for bucks can be installed. A combination of cage sizes are shown but the number and size of cages can be altered by the owner.

Stacking of cages vertically is an excellent way to make efficient use of building space. Two or three levels can be installed by attaching them to free-standing supports or hanging cables. If the cages are to be suspended from the ceiling, extra strength must be designed in the truss assembly to accommodate the extra weight of cages, rabbits and feed. The length of this house can be extended to provide additional housing capacity.

Copies of this plan can also be obtained by contacting your Mississippi County Extension Office and requesting House Plan #6360, 2 Multi-Row Caged Rabbit Shed.

**Dr. Tom W. Smith, Professor of Poultry Science and Extension Poultry Specialist
Poultry Science Department, Mississippi State University.
May, 2000.**